

Fig. 4.

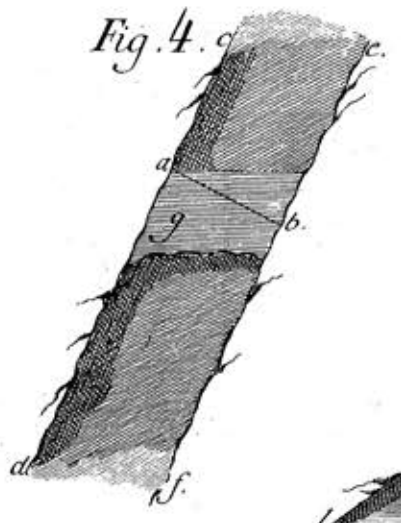

Fig. 5.

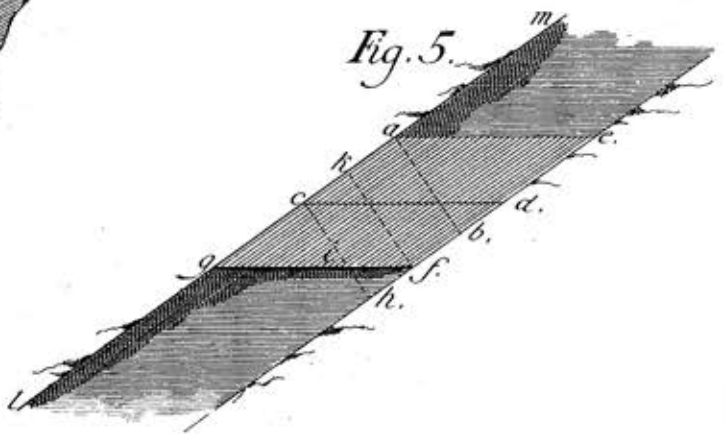

Fig. 6.

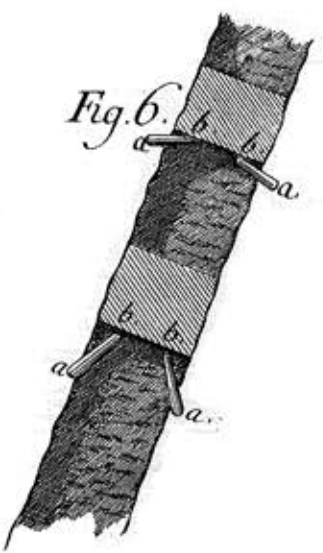

Fig. 7.



Fig. 12.

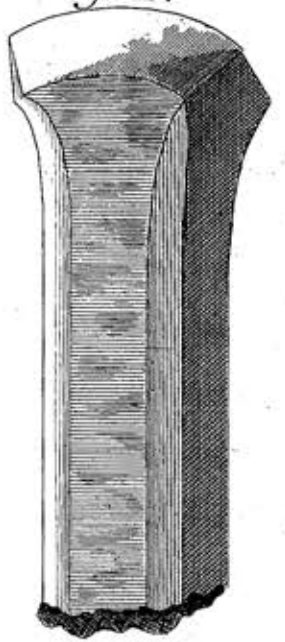

Fig. 3.

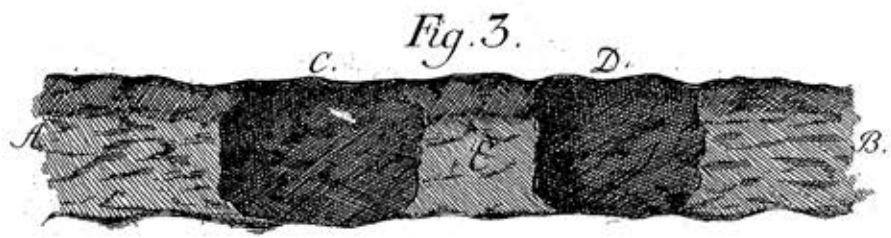

Fig. 8.

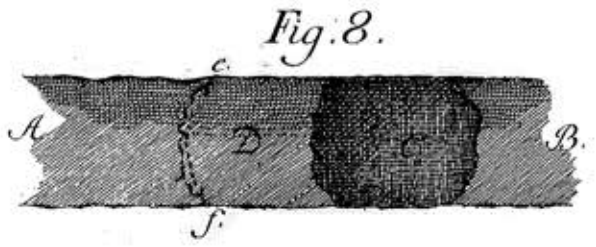

Fig. 9.

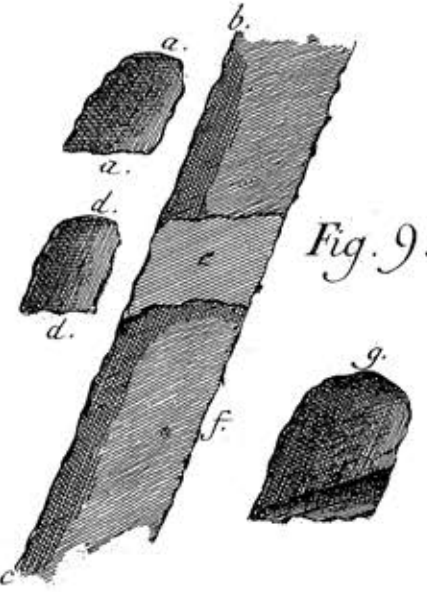

Fig. 1.

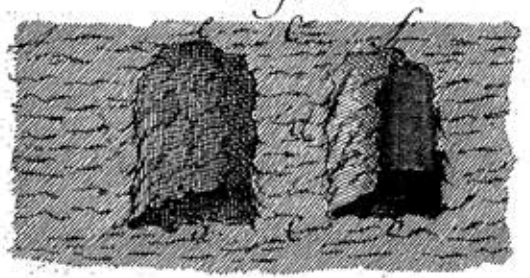

Fig. 2.

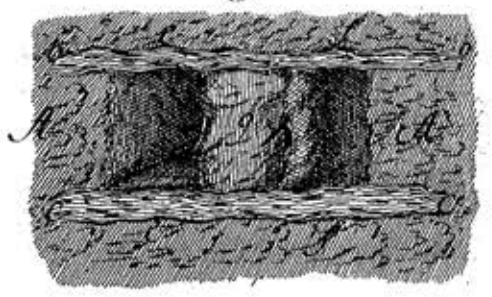

Fig. 13.

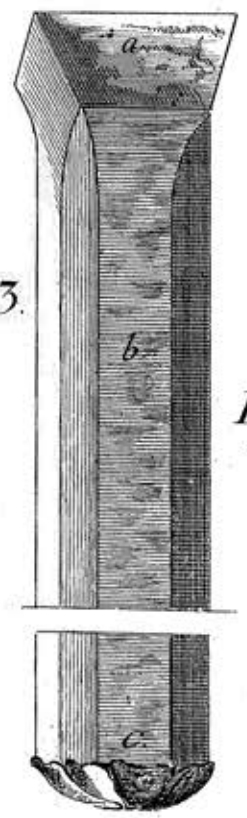

Fig. 16.

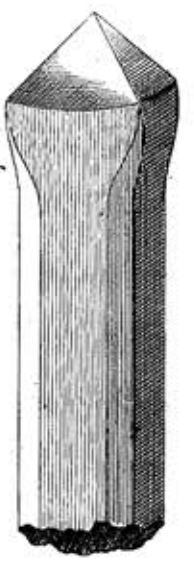

Fig. 15.

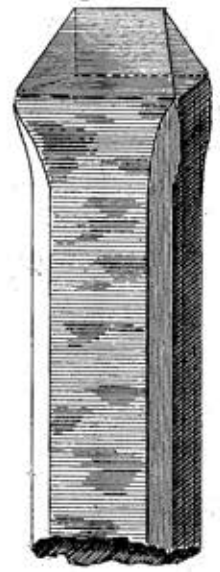

Fig. 14.

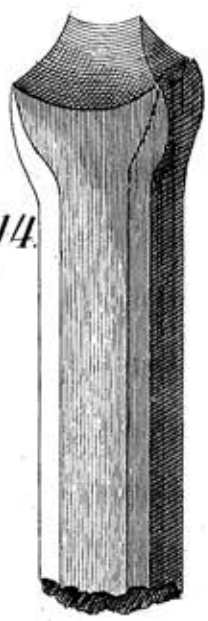

Fig. 17.



Fig. 10.

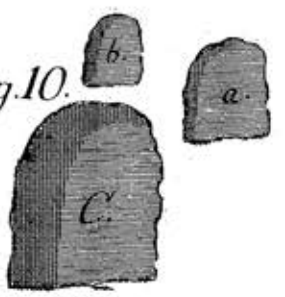

Fig. 11.

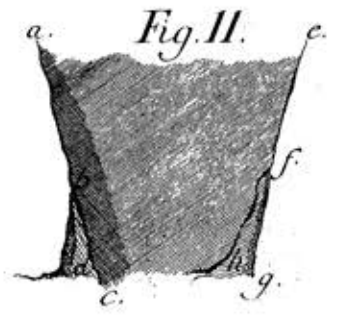
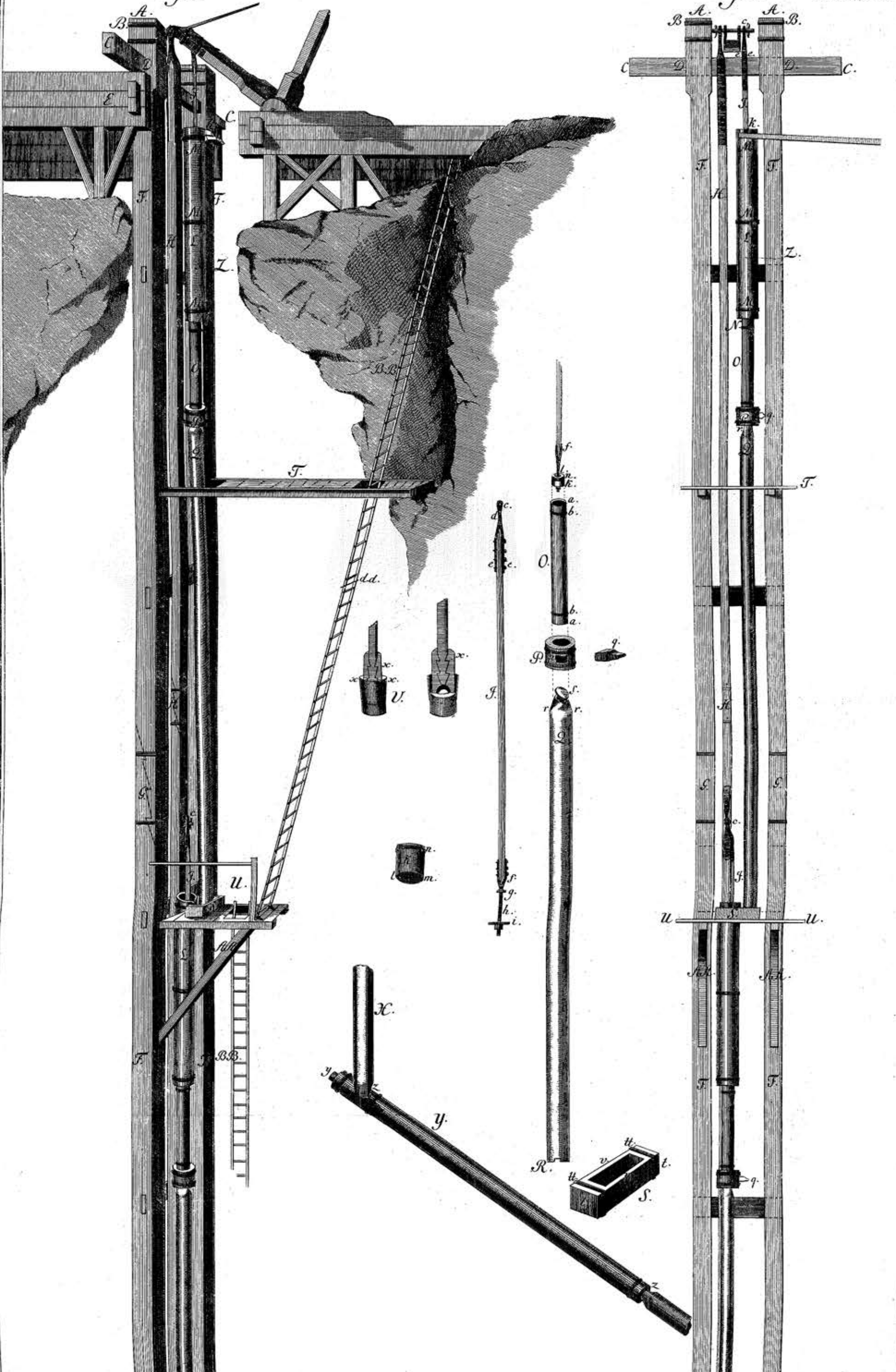

Fig. 1.

Fig. 2.



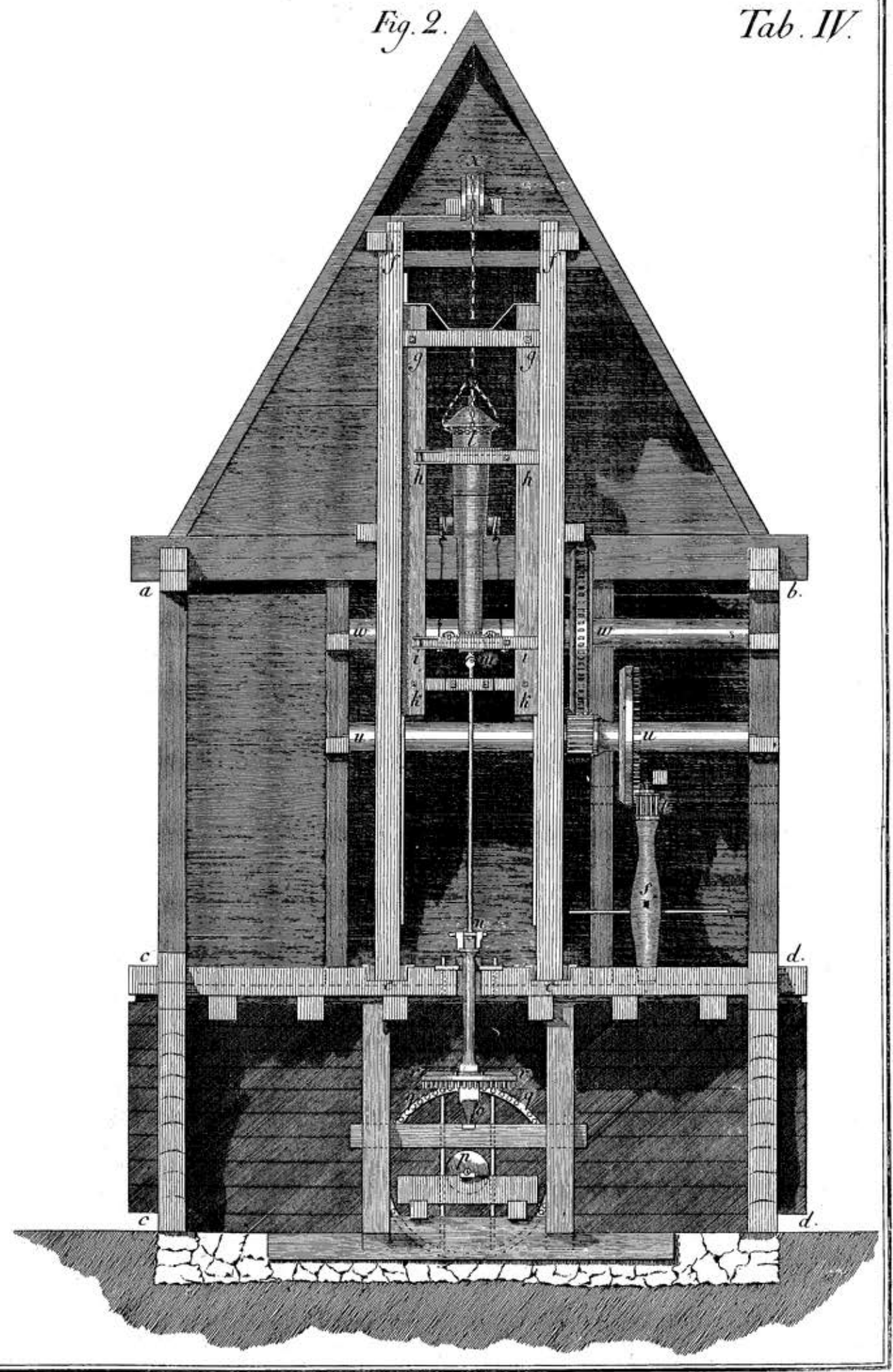
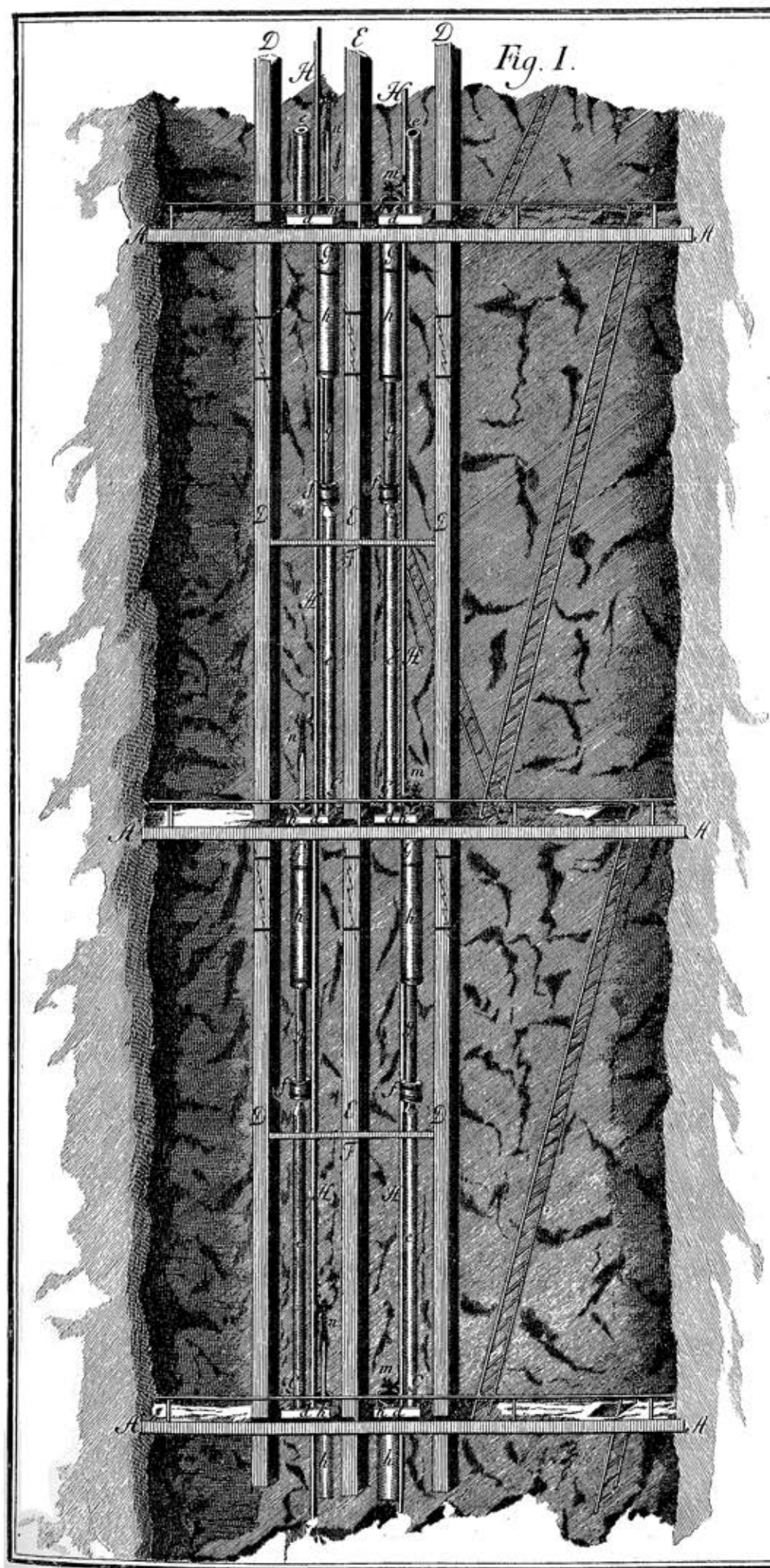

Fig. 1.

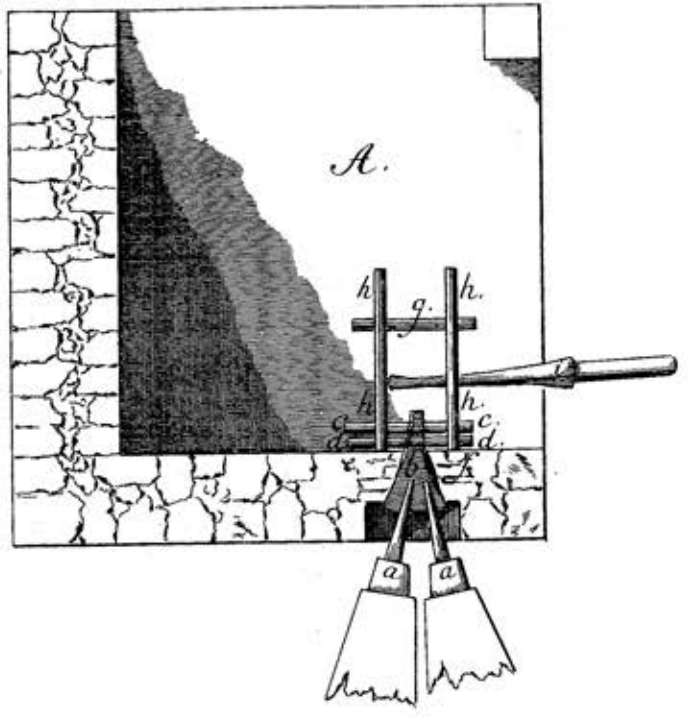

Fig. 3.

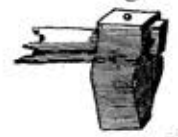

Fig. 4.



Fig. 2.

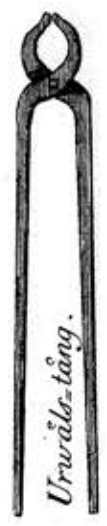

Fig. 5.

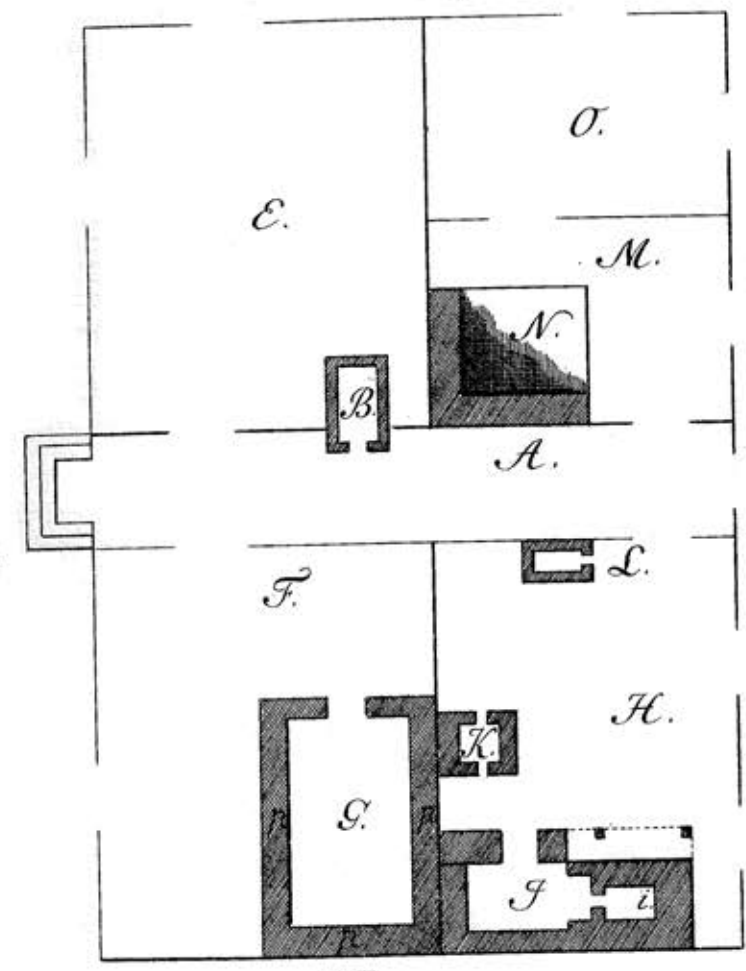

Fig. 8.

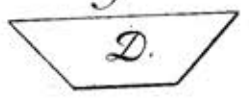

Fig. 6.

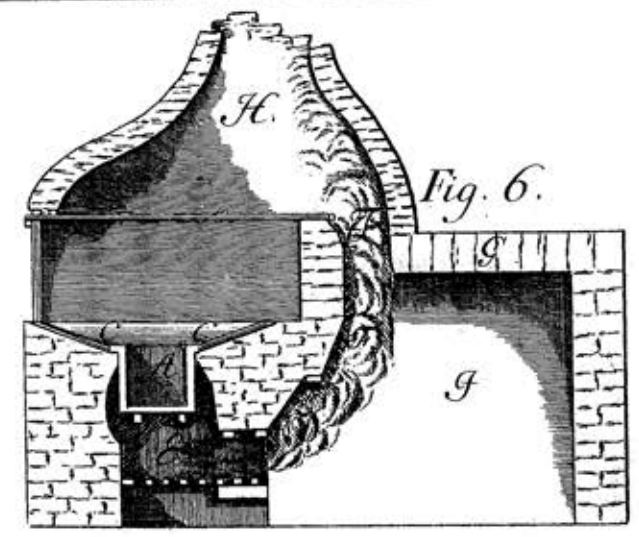

Fig. 7.



Fig. 4.

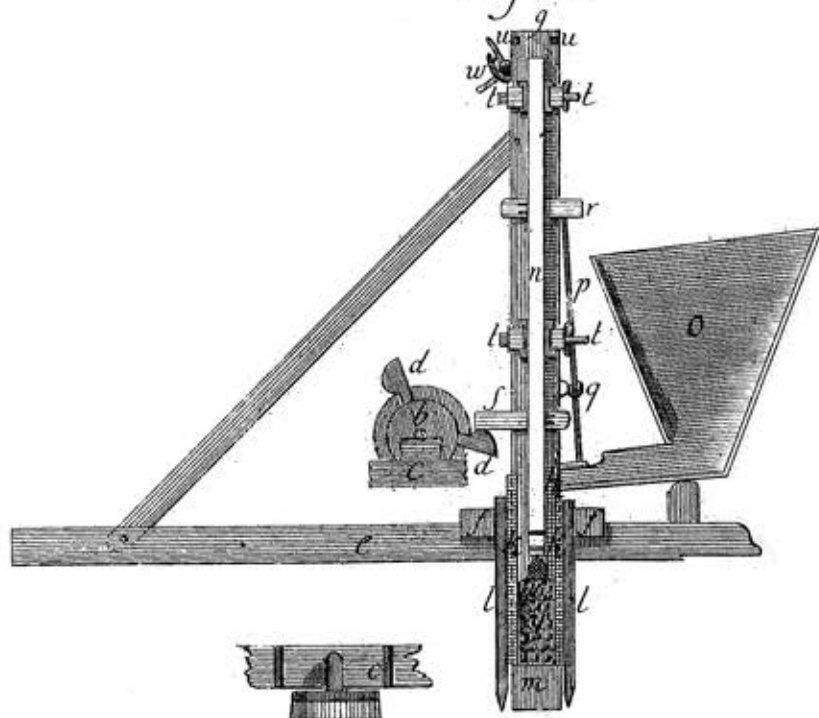

Fig. 1.

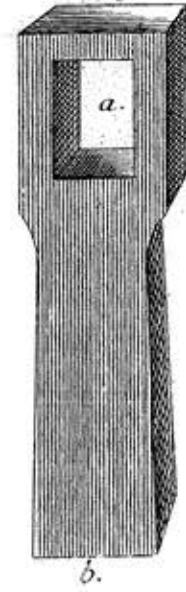

Fig. 2.

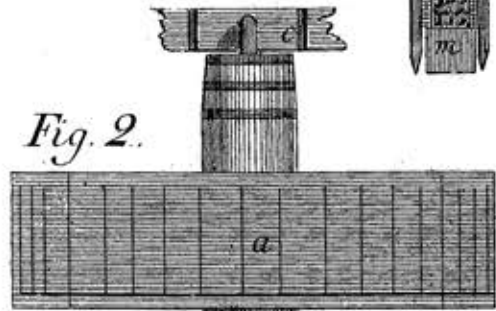

Fig. 3.

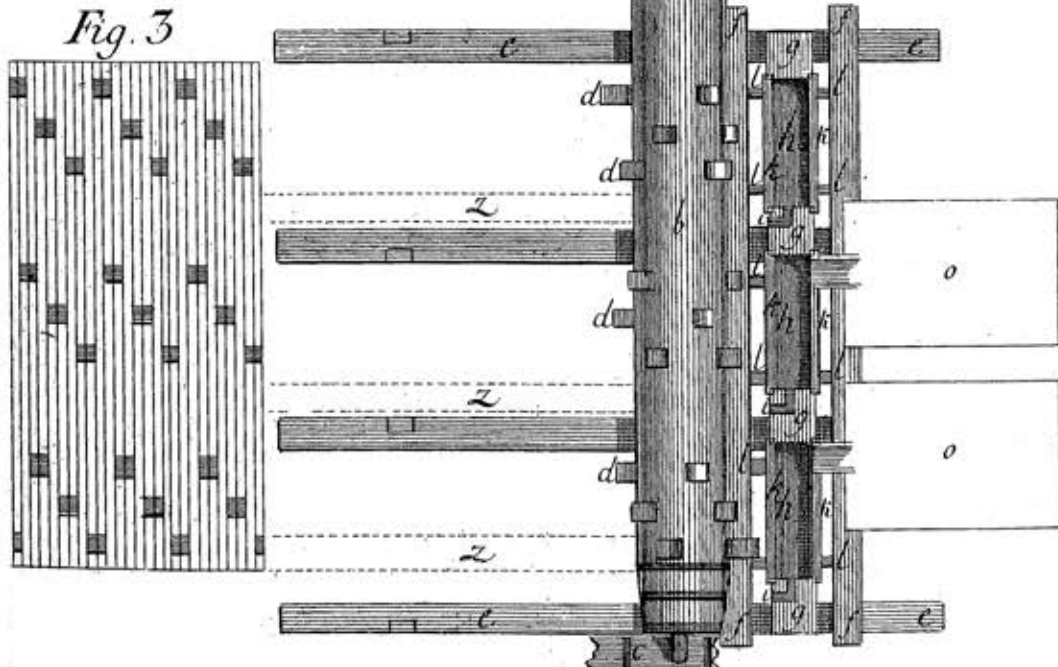

Fig. 6.

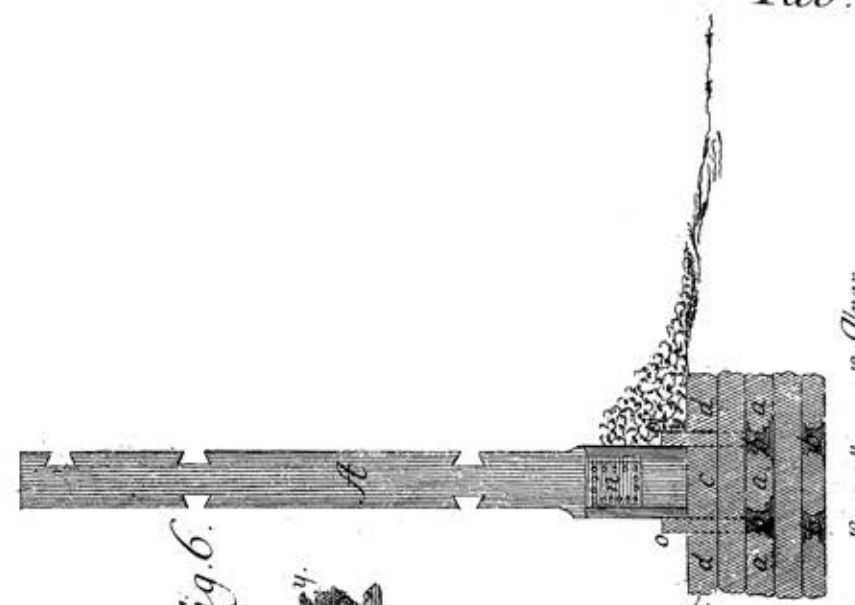
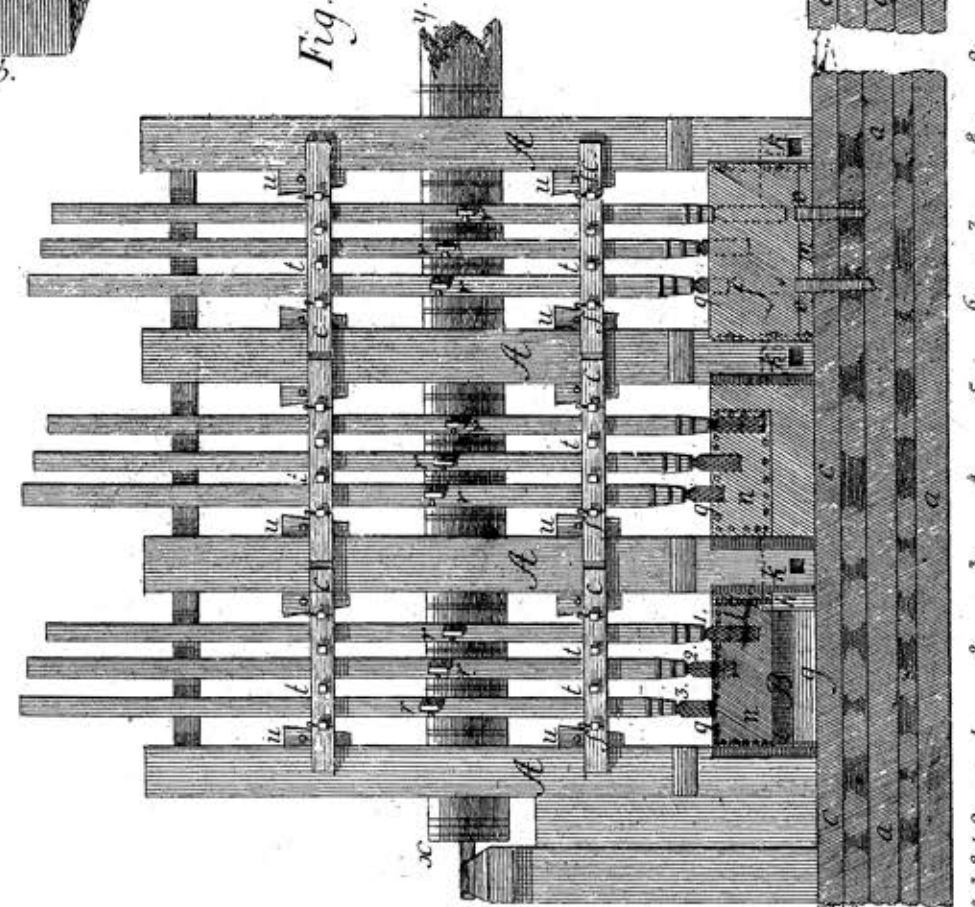

Fig.



0 1 2 3 4 5 6 7 8 9 Alnar.

0 1 2 3 4 5 6 7 8 9 10 Alnar.

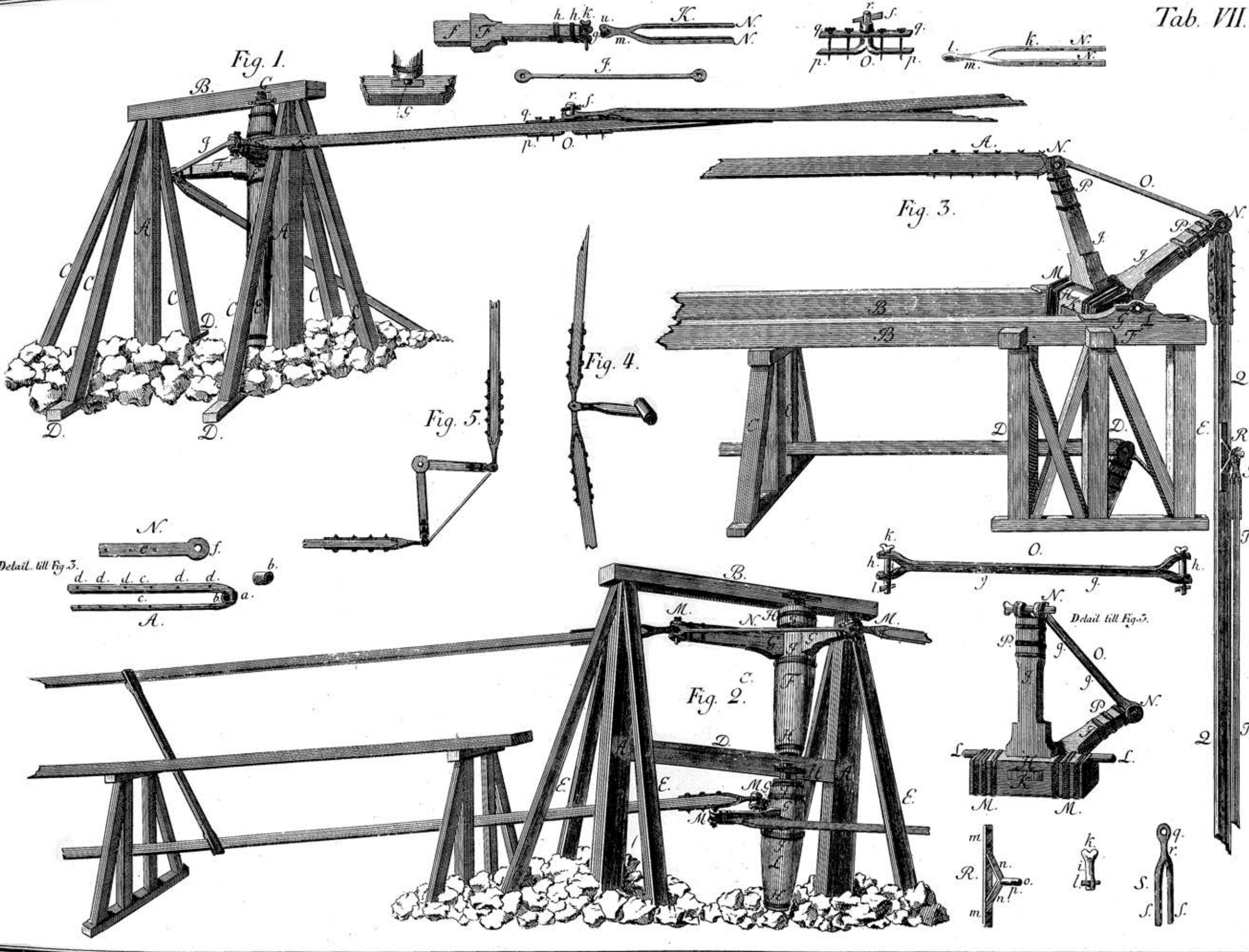

Fig. 1.

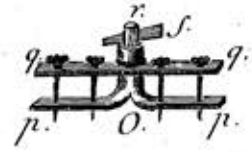
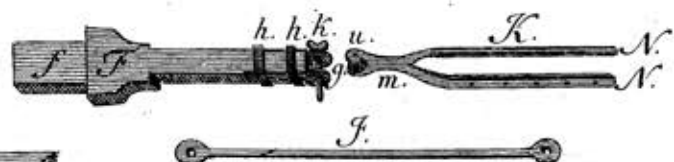
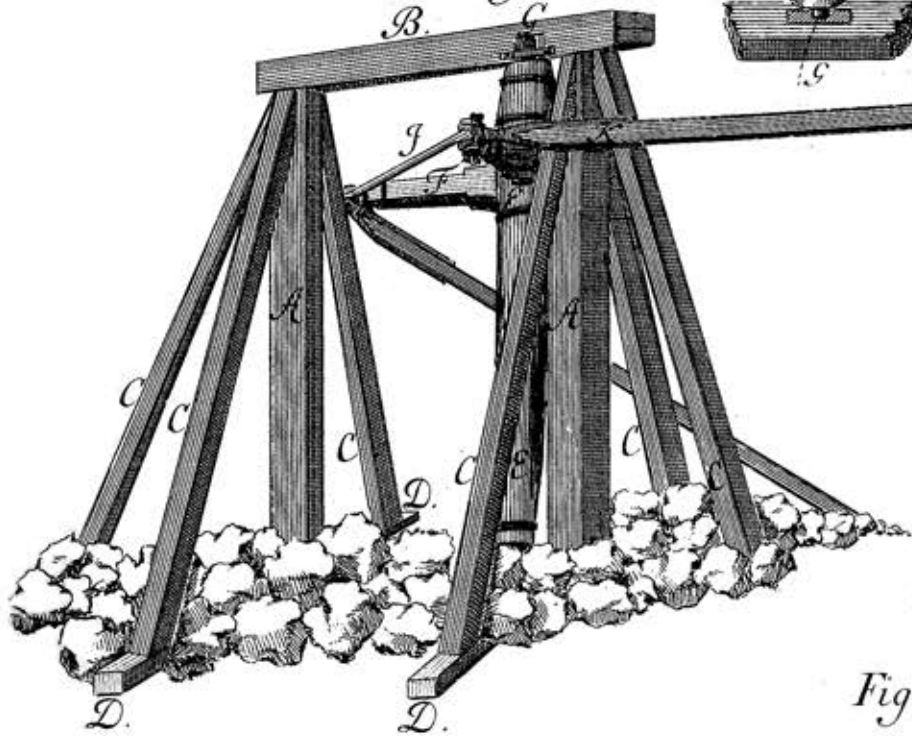

Fig. 3.

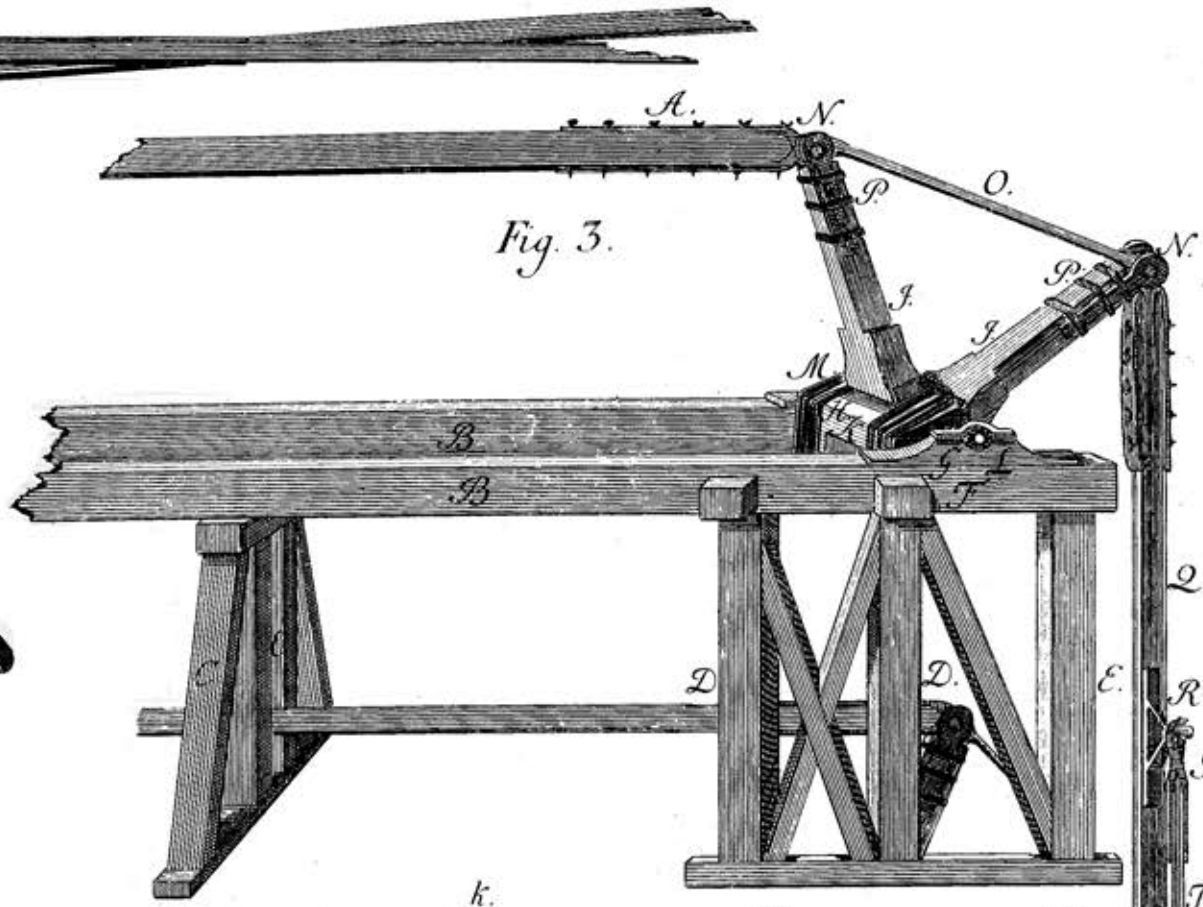
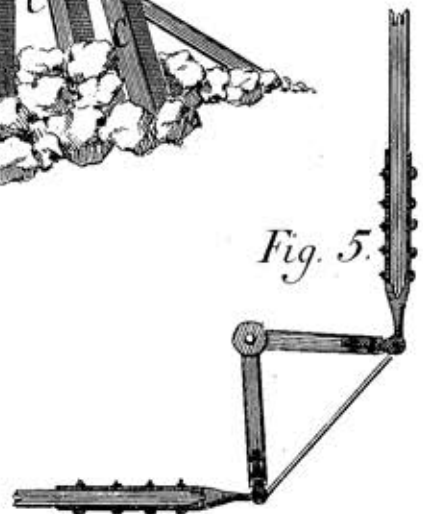

Fig. 4.



Fig. 5.



Detail till Fig. 3.

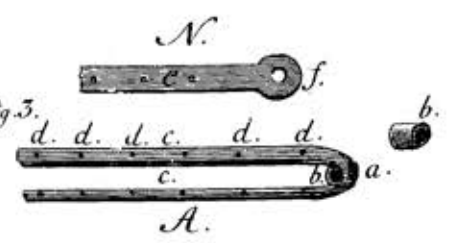
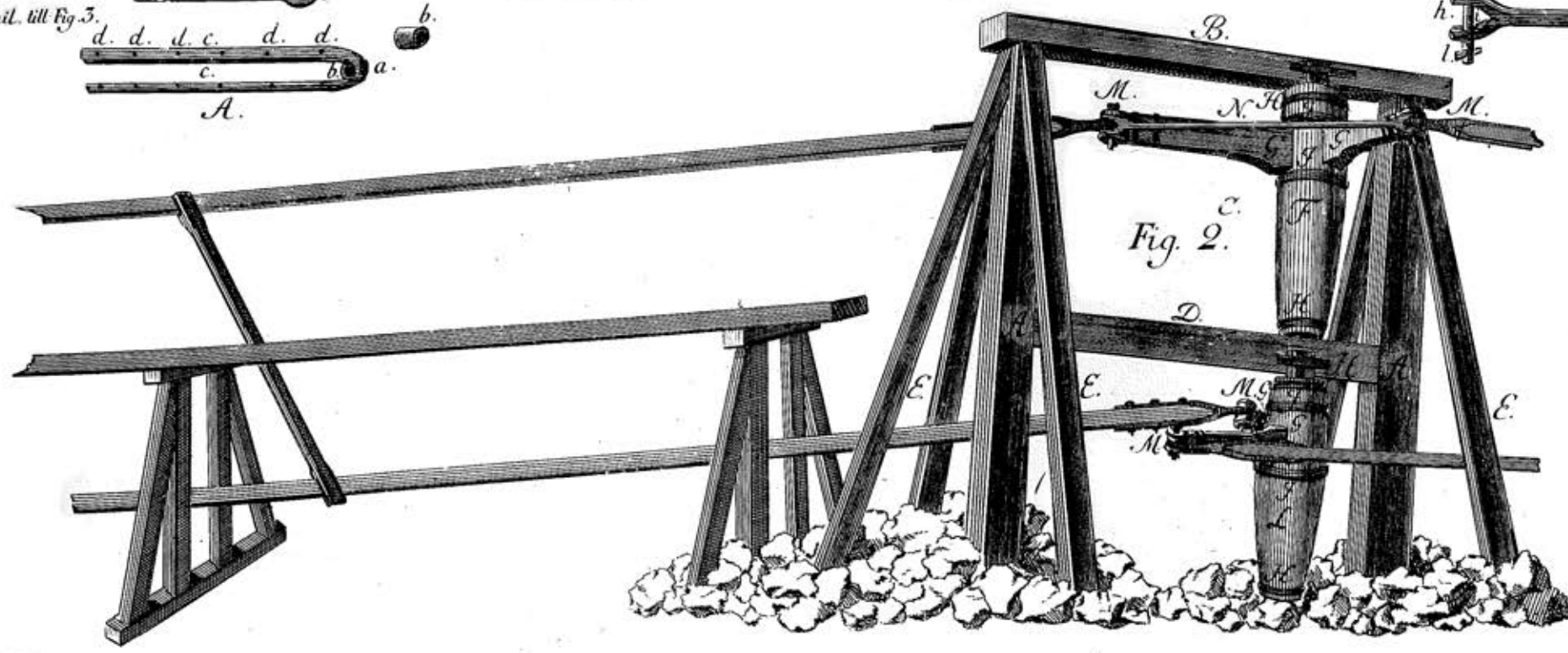

Fig. 2.



Detail till Fig. 5.

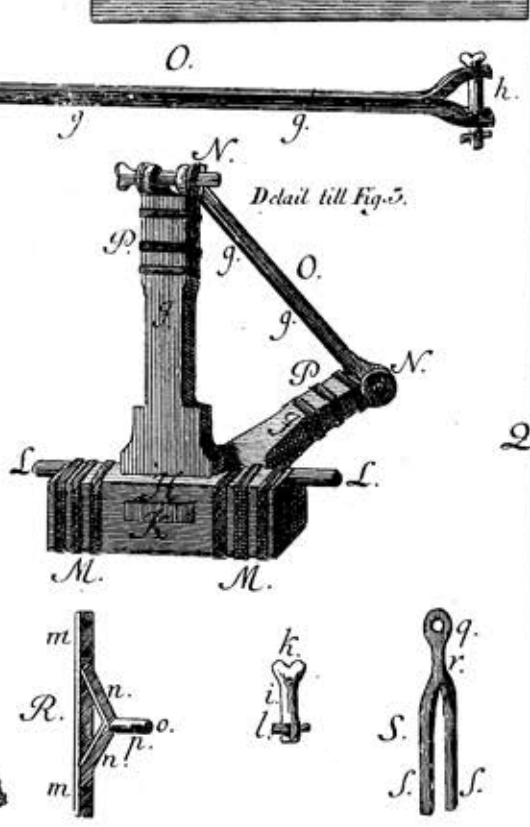

Fig. 1.

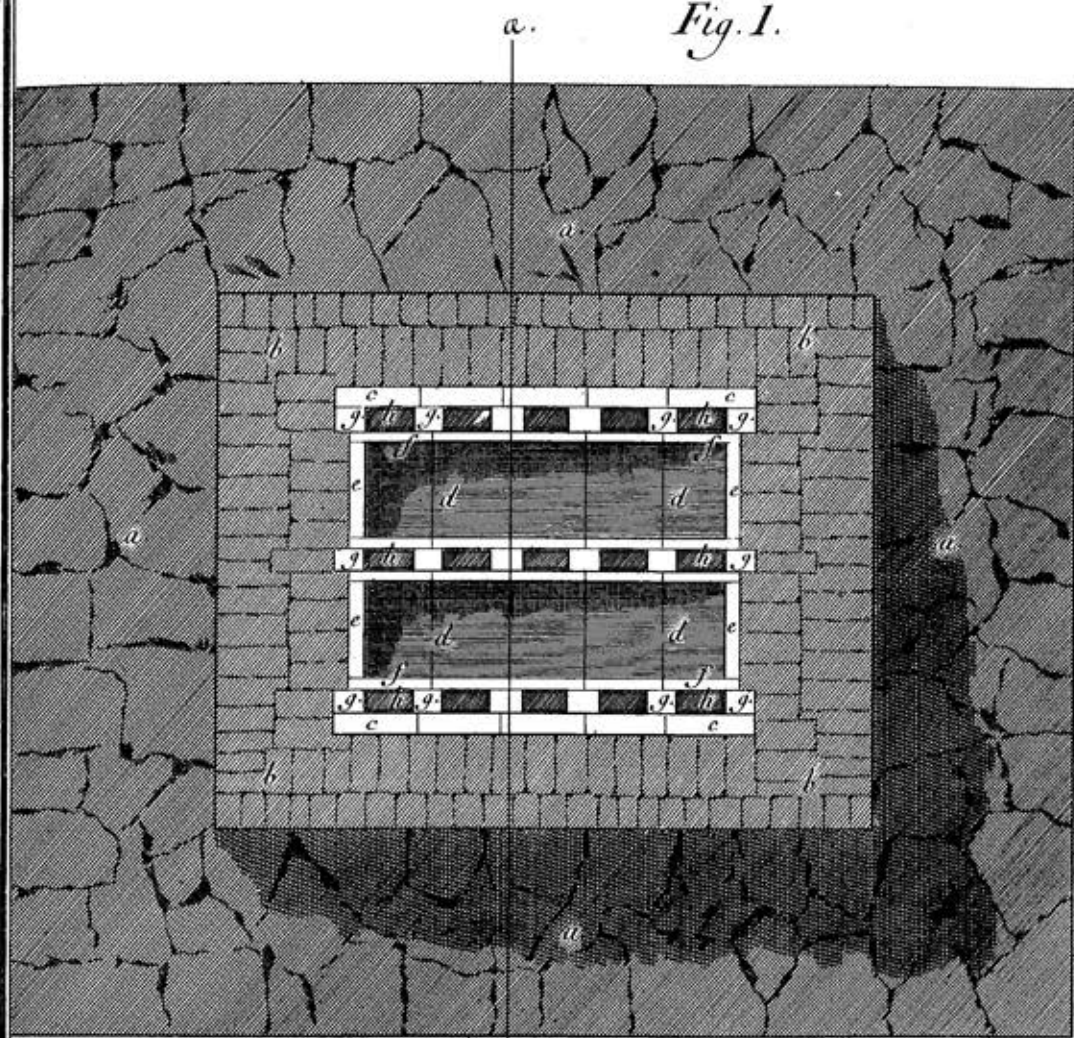

Fig. 2.

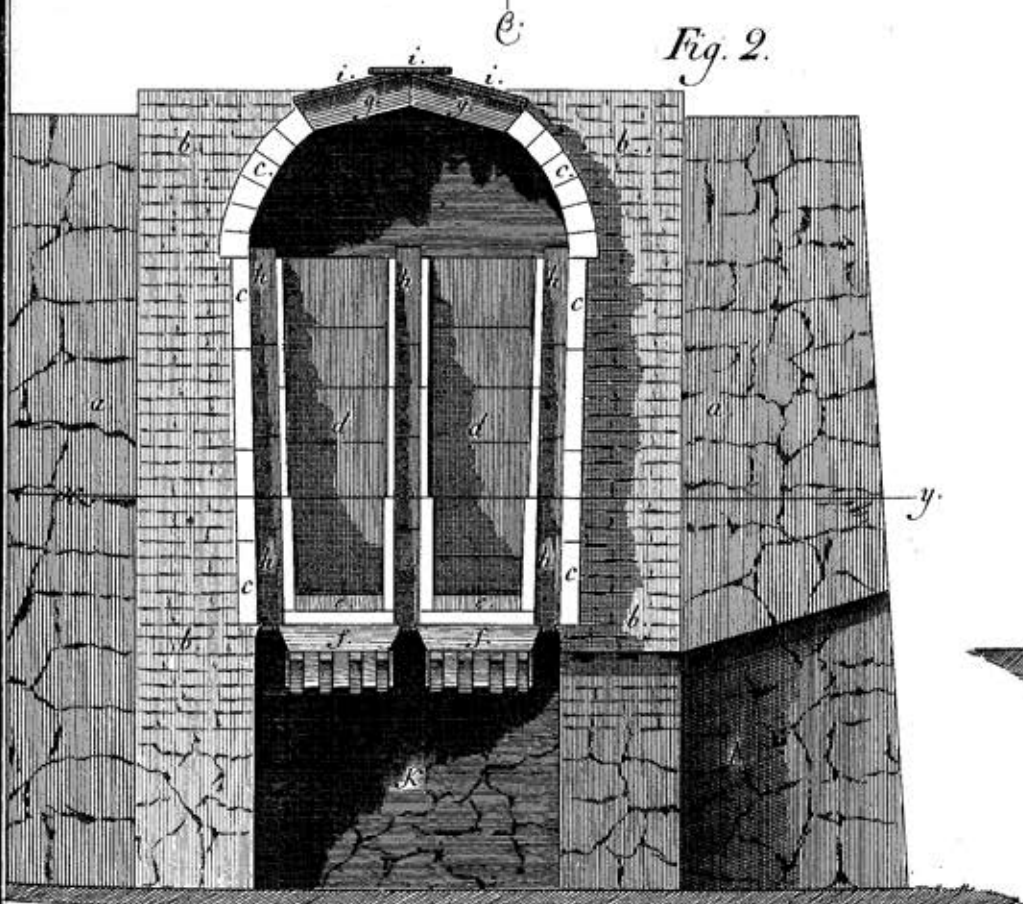
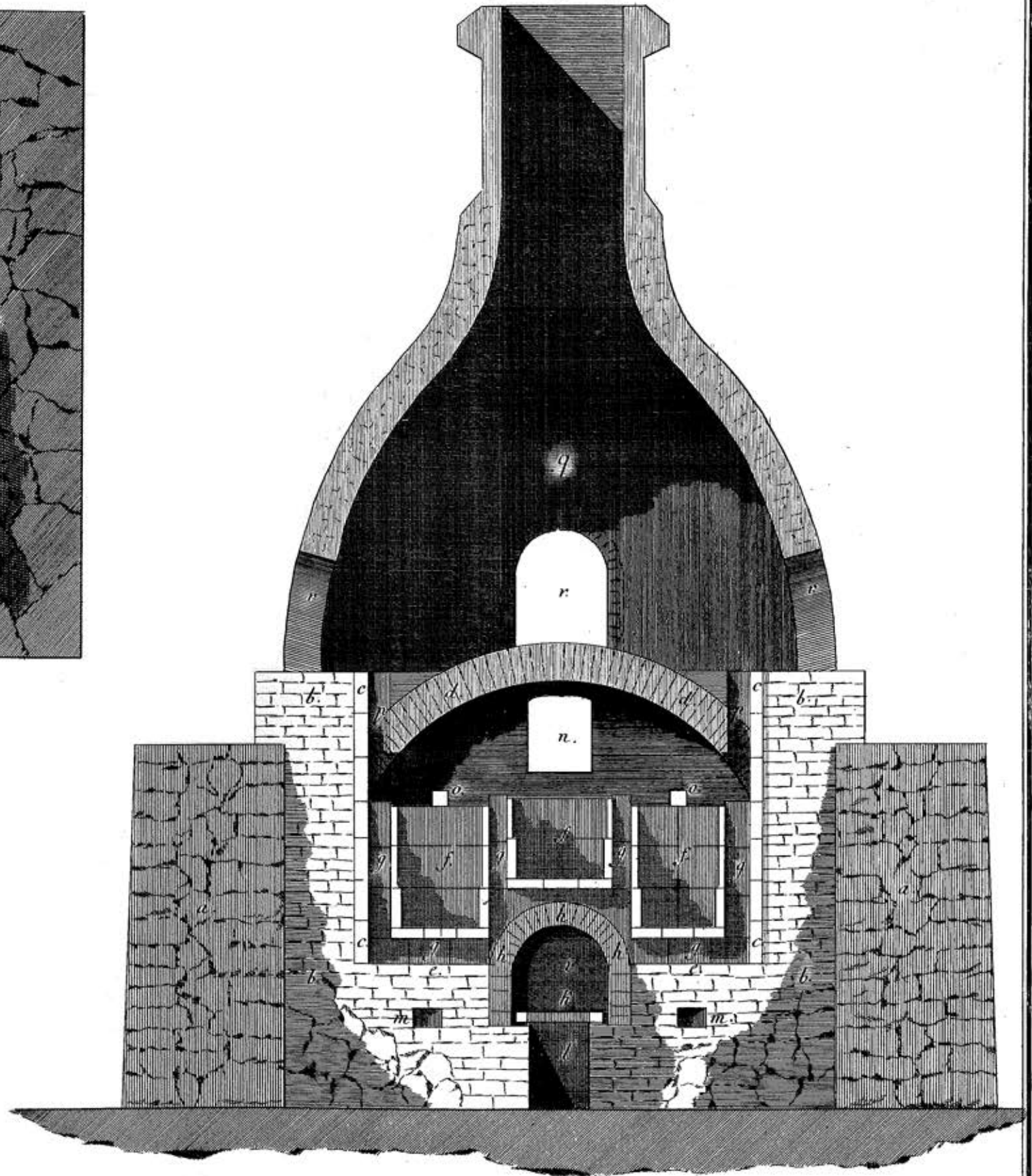

Fig. 3.



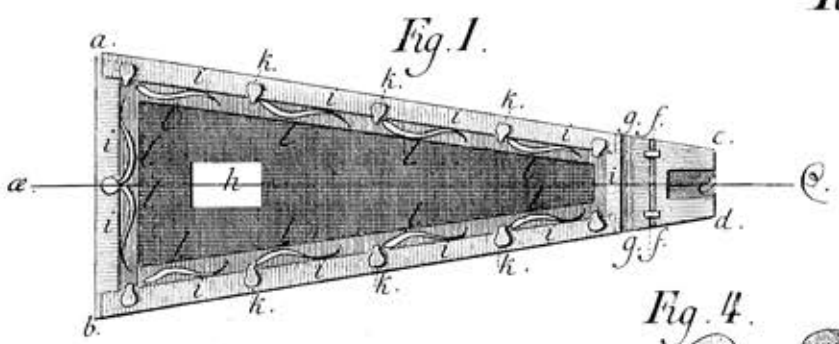
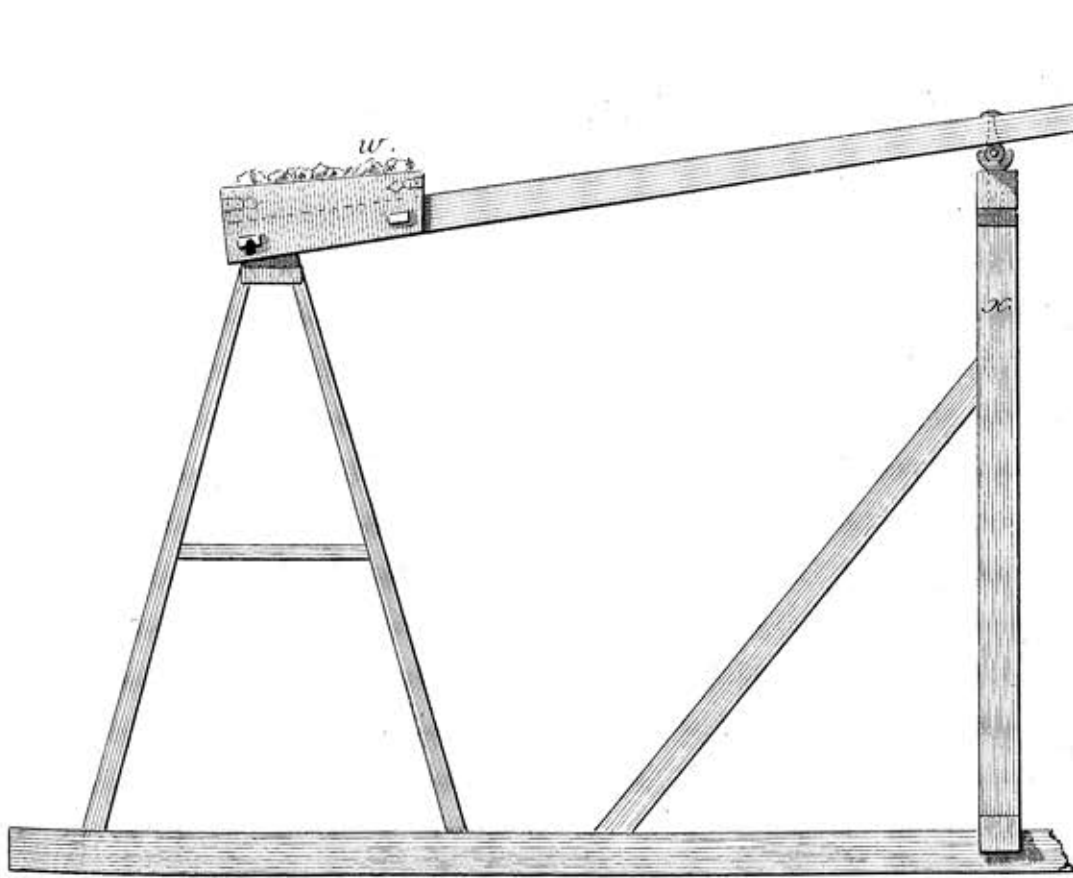

Fig. 4.

Fig. 5.

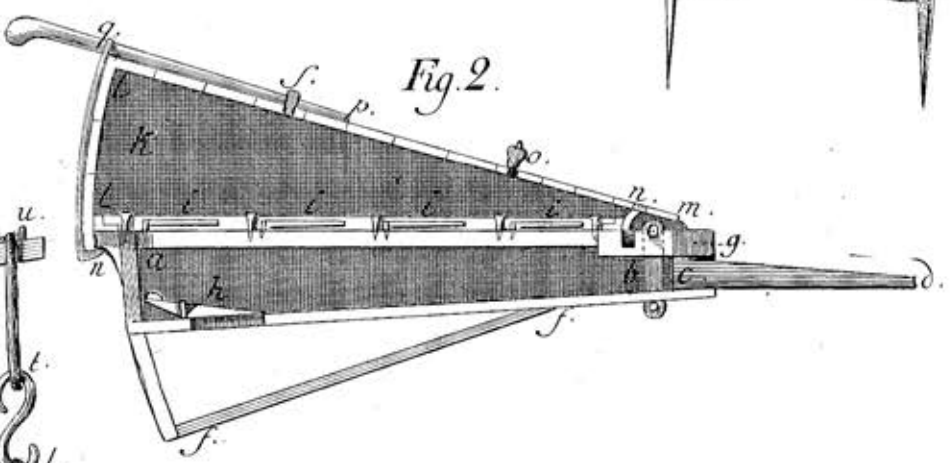

Fig. 2.

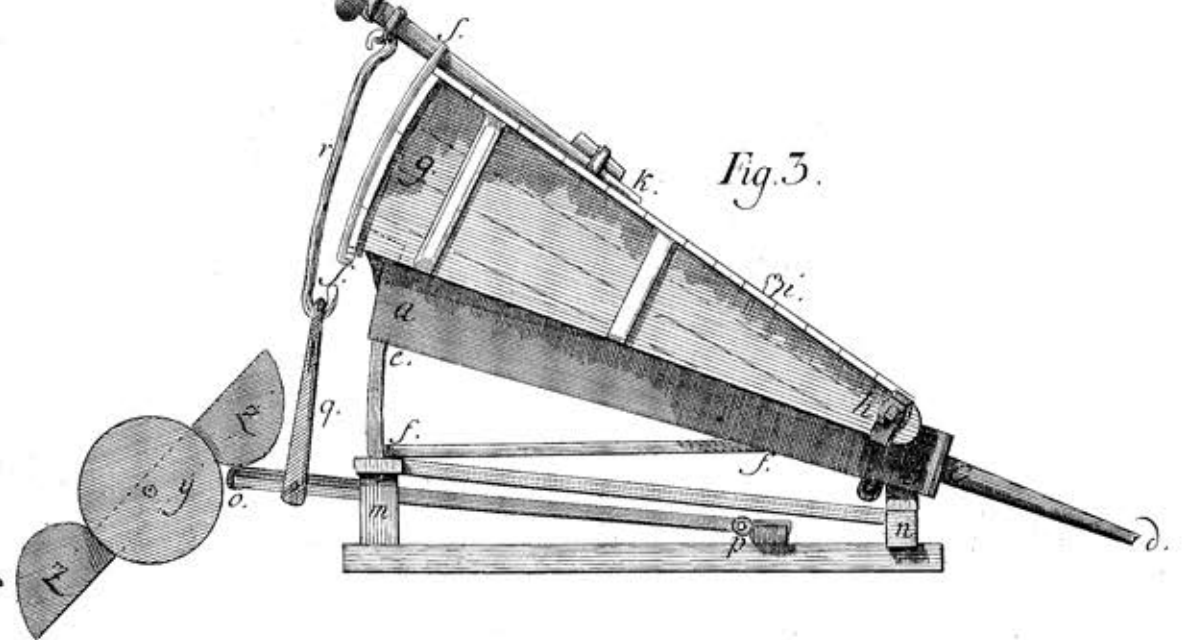

Fig. 3.

Fig. 3.

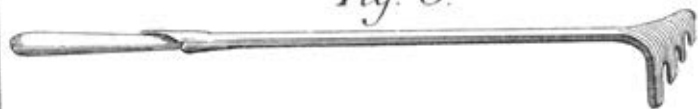

Fig. 2.

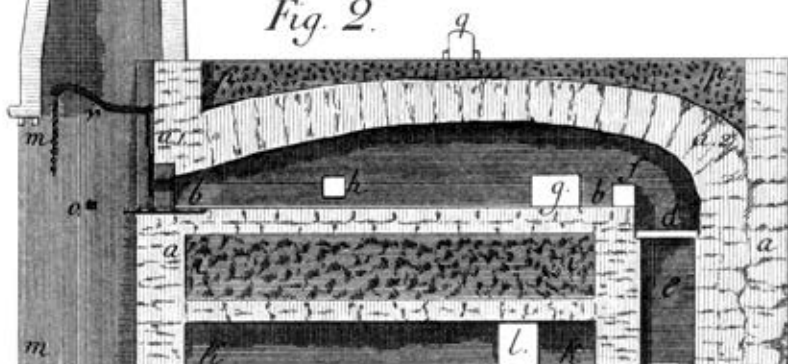
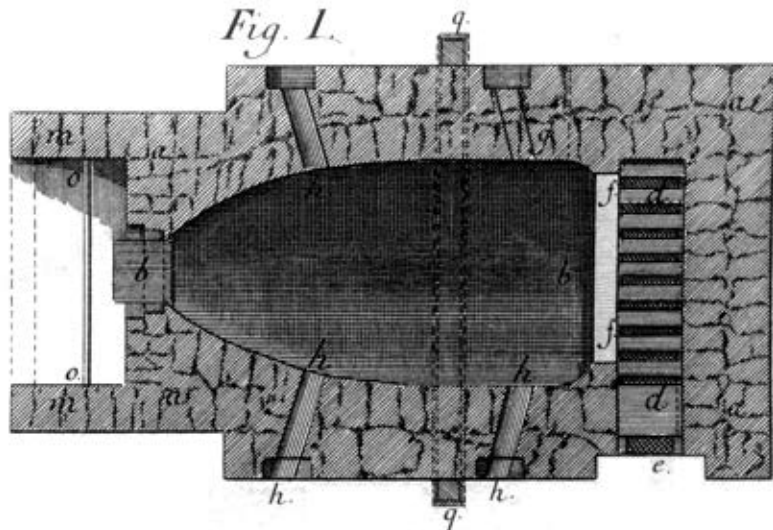

Fig. 1.



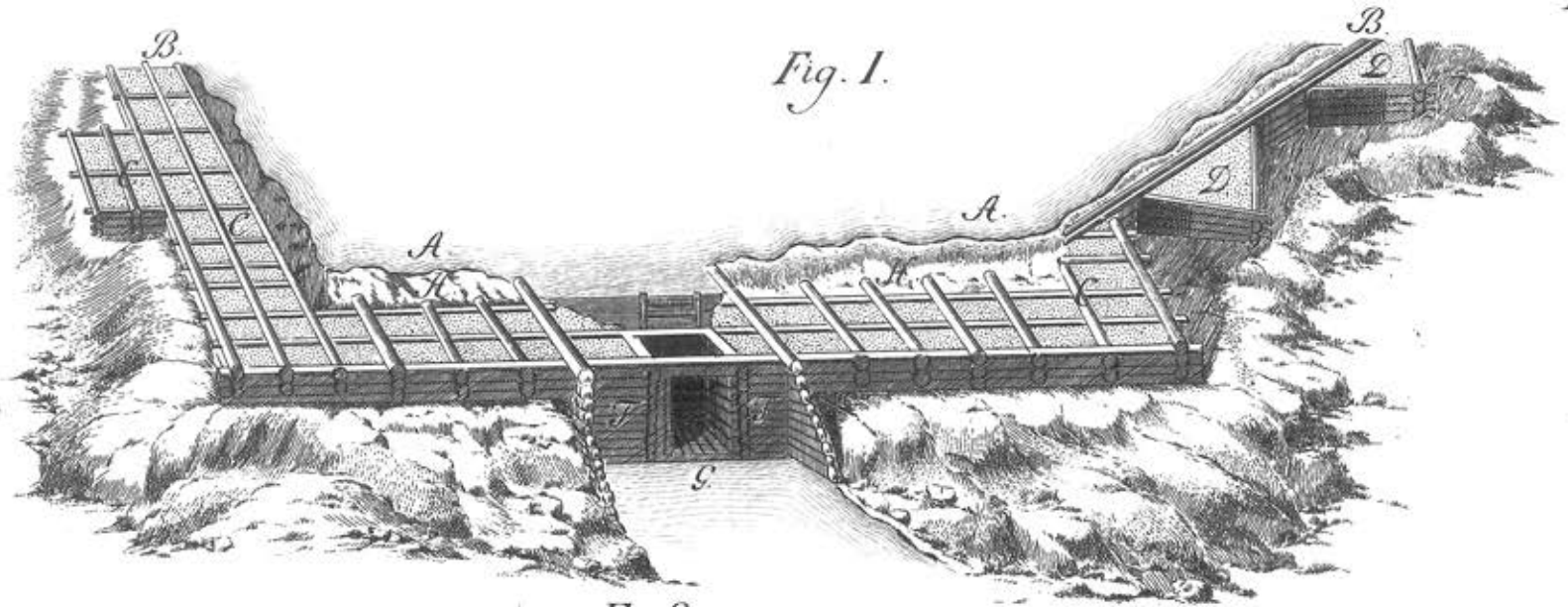

Fig. 1.

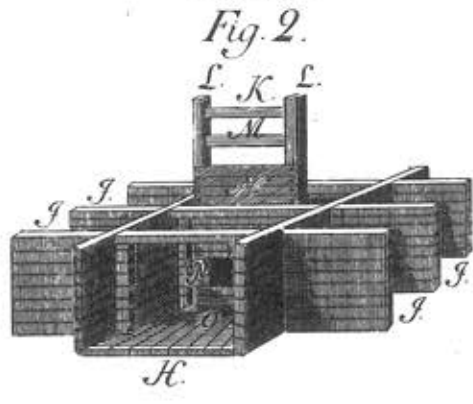

Fig. 2.

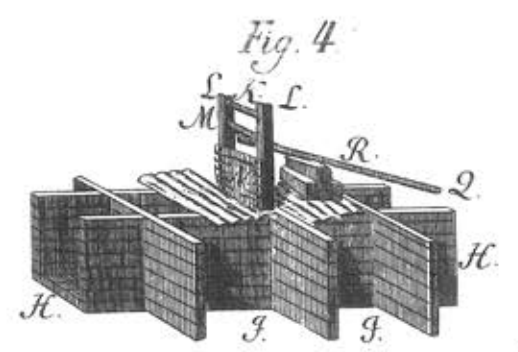

Fig. 4.

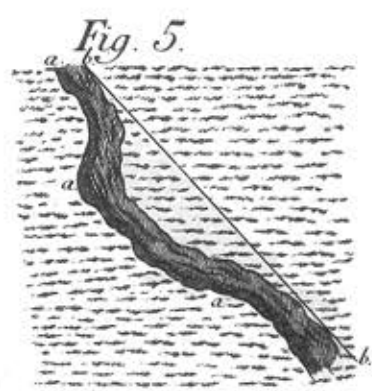

Fig. 5.

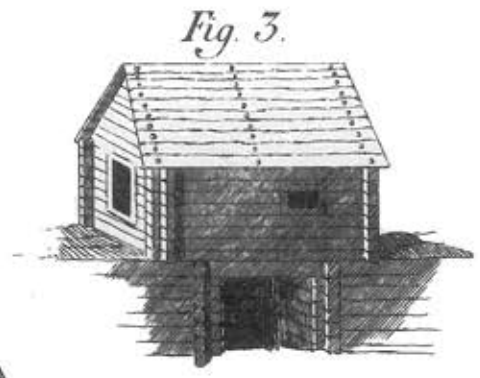

Fig. 3.

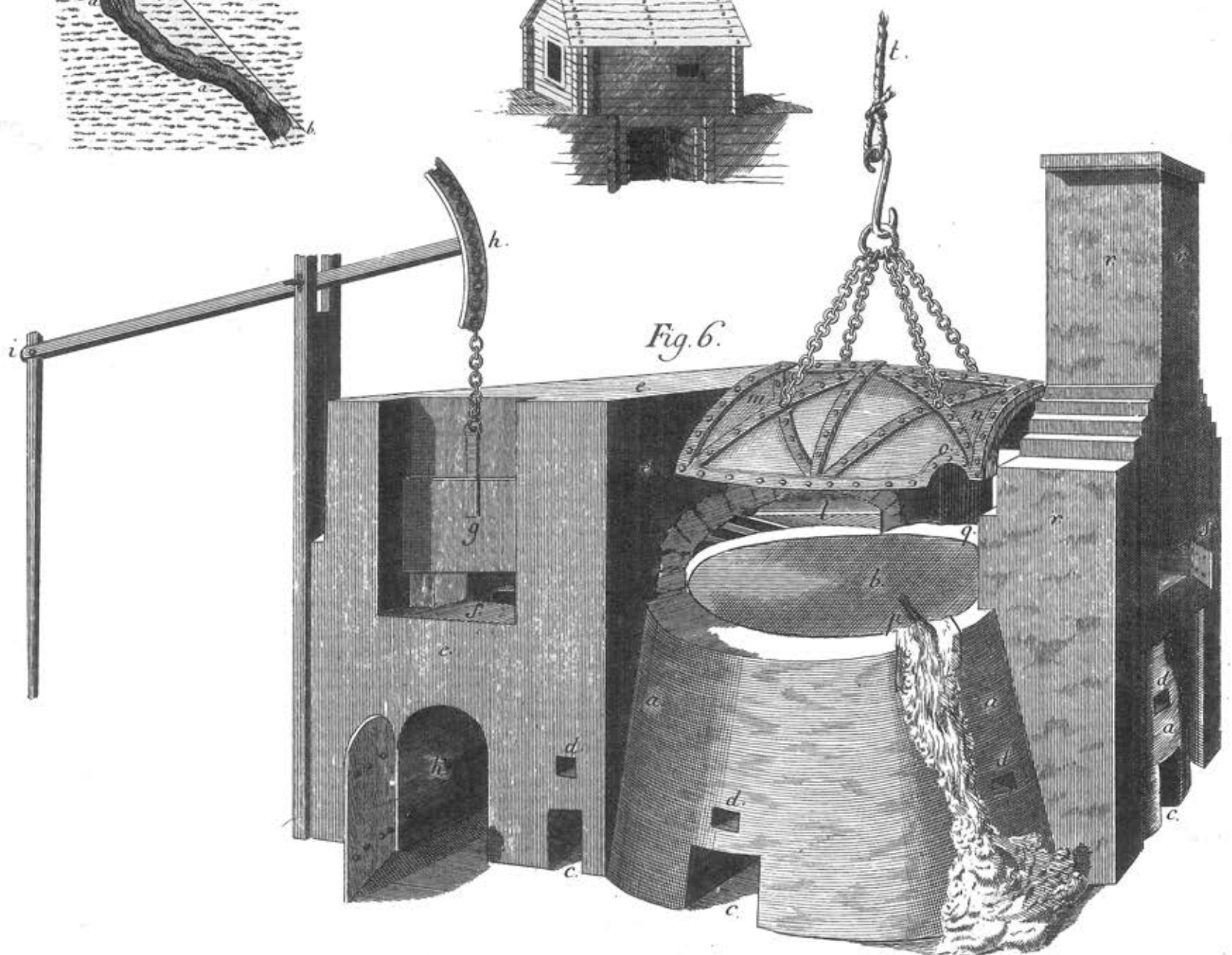

Fig. 6.

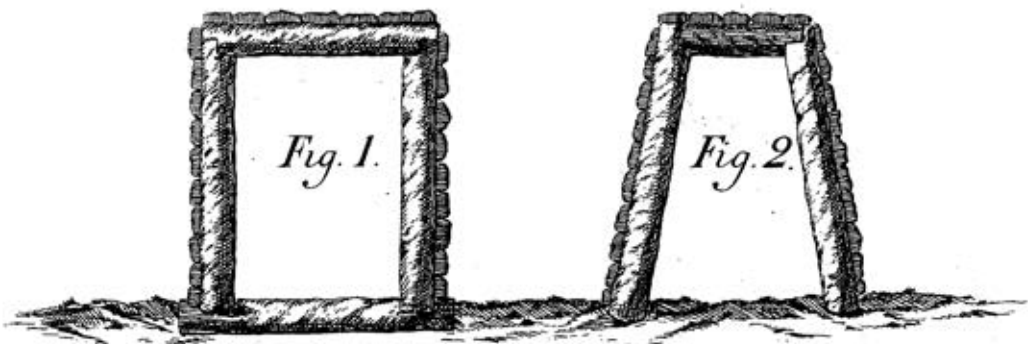

Fig. 3.



Fig. 4.



Fig. 5.



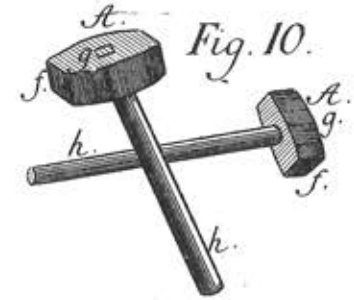
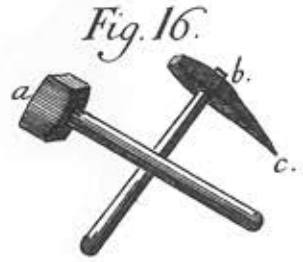
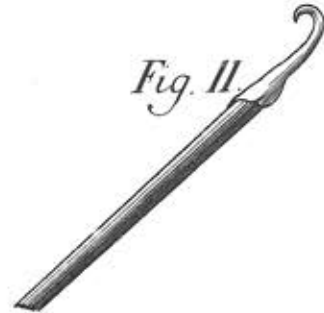
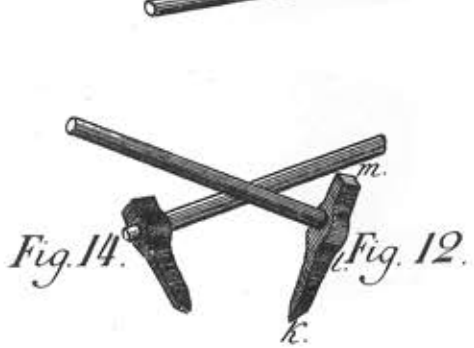
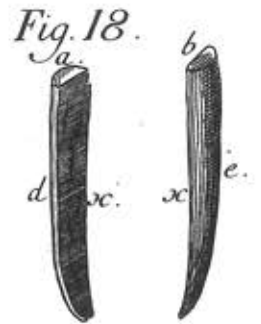
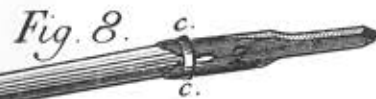
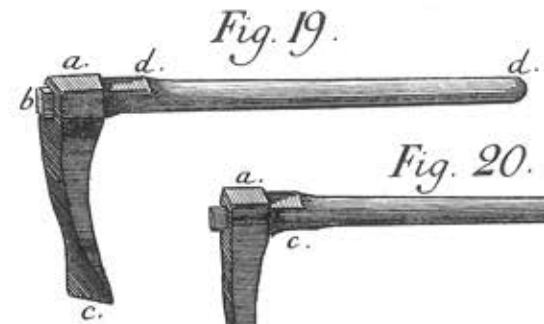
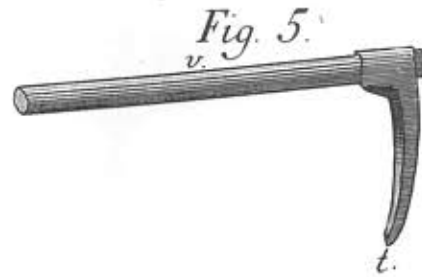
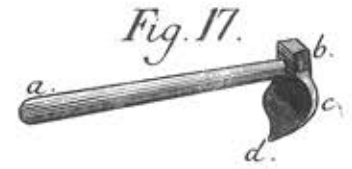
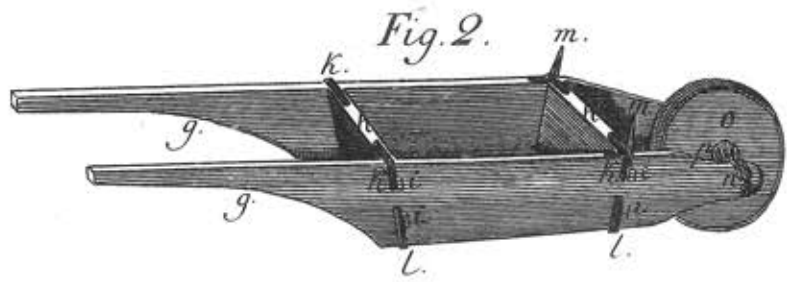

Fig. 1.

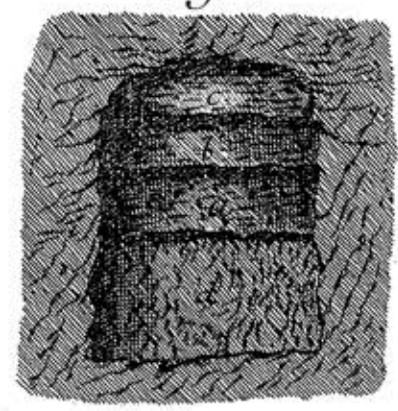

Fig. 2.

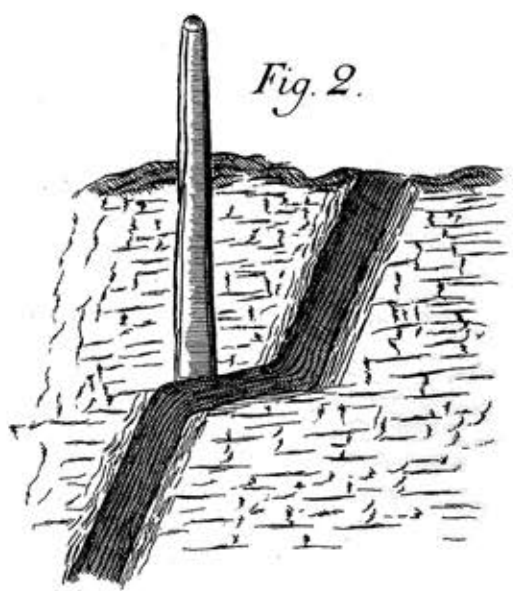

Fig. 3.

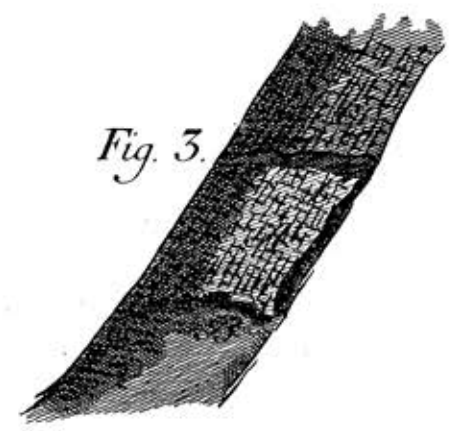

Fig. 8.

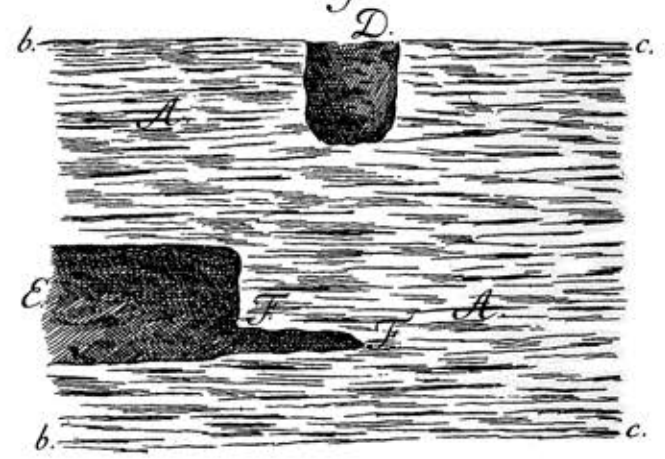

Fig. 7.



Fig. 4.

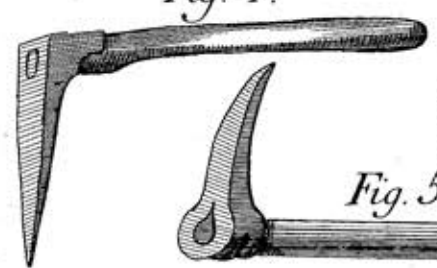

Fig. 6.

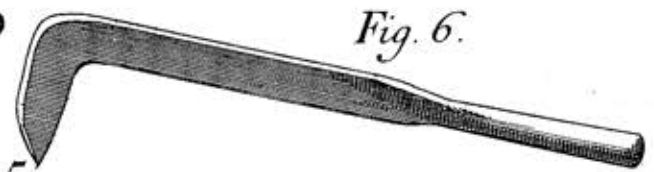

Fig. 5.

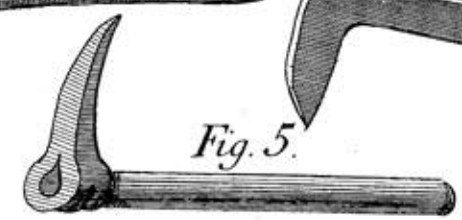

Fig. 10.

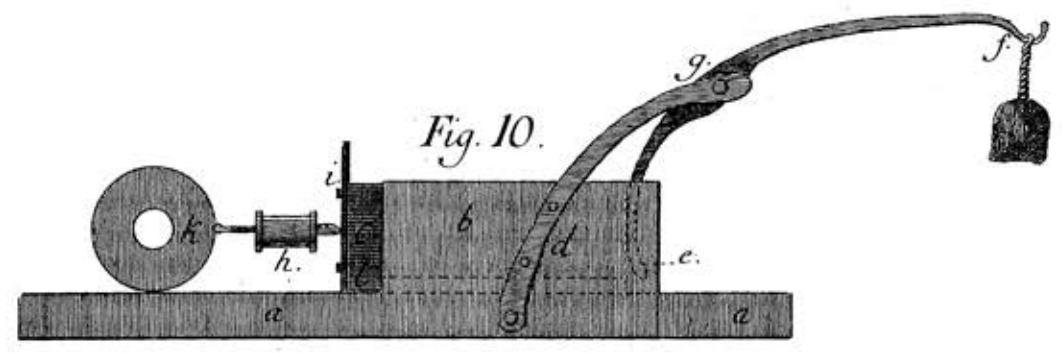

Fig. 9.

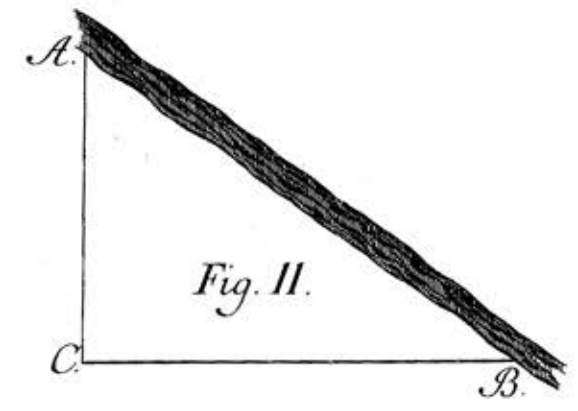
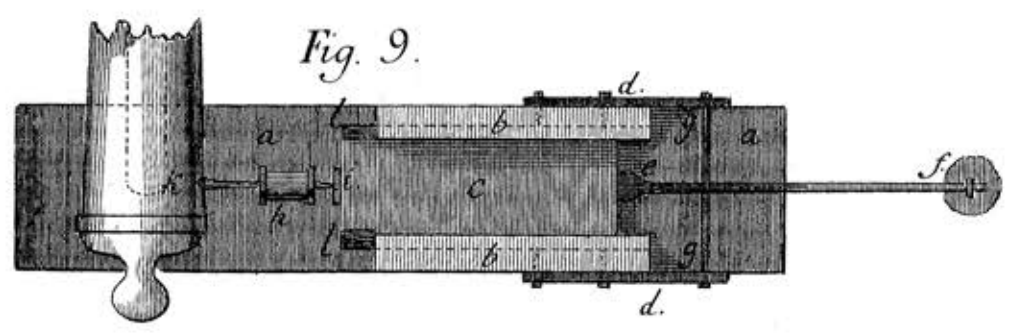

Fig. 11.

Fig. 3.

Tab. XV.

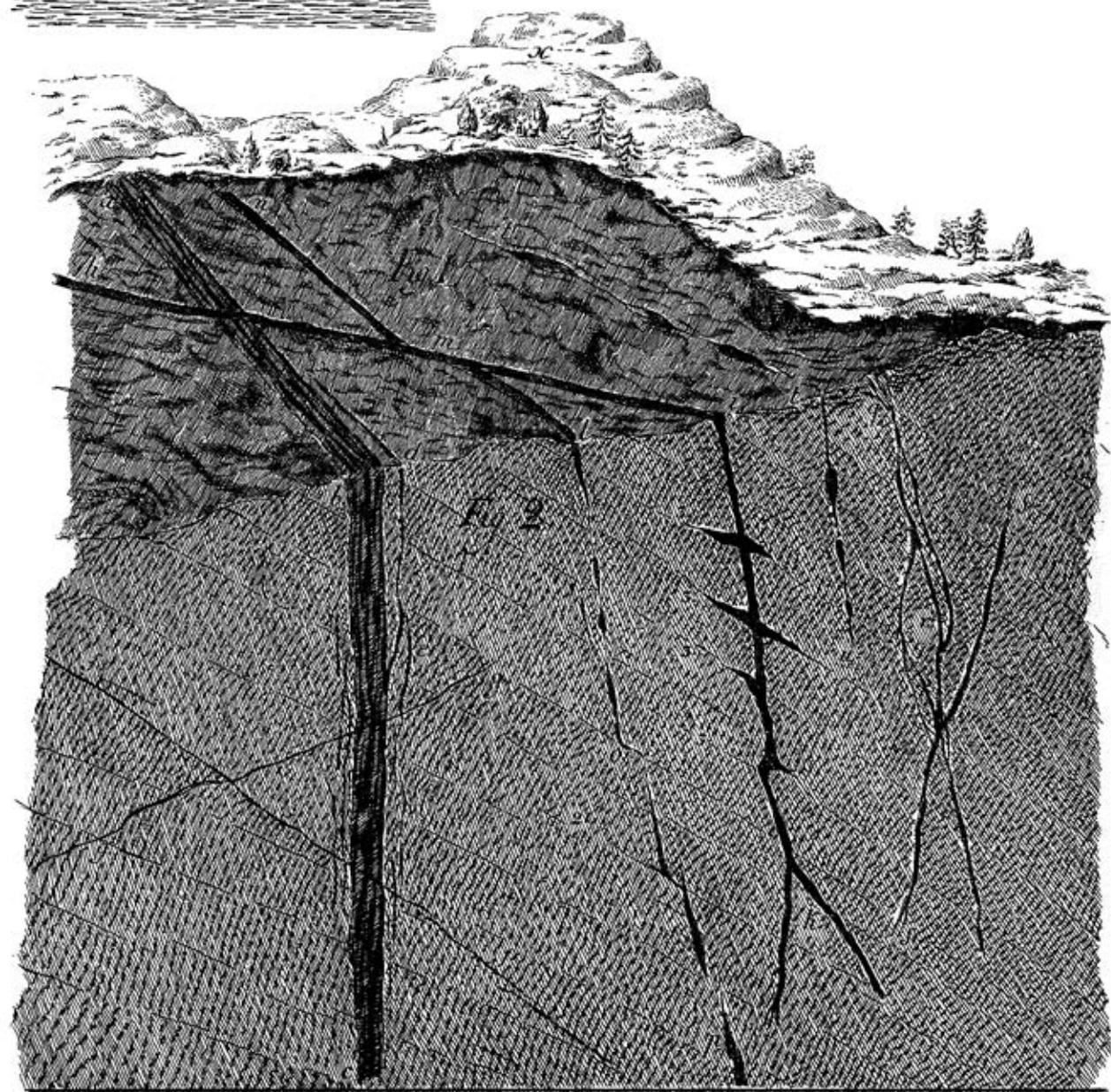
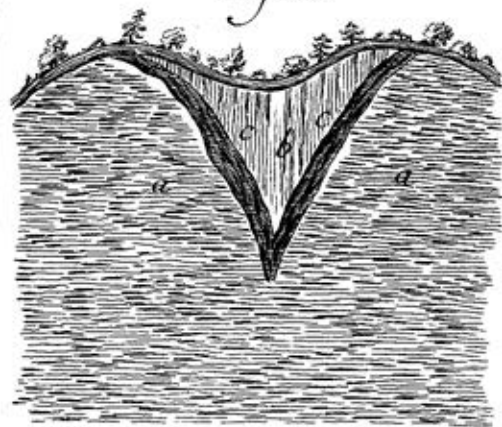
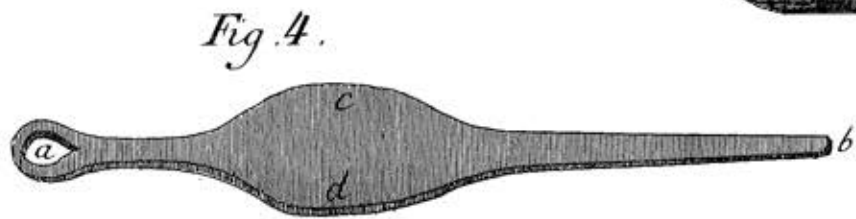
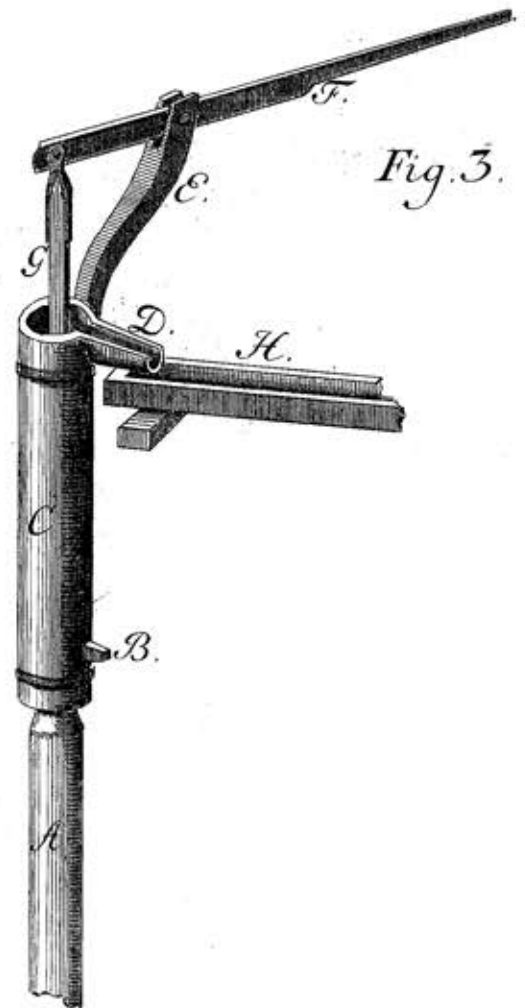
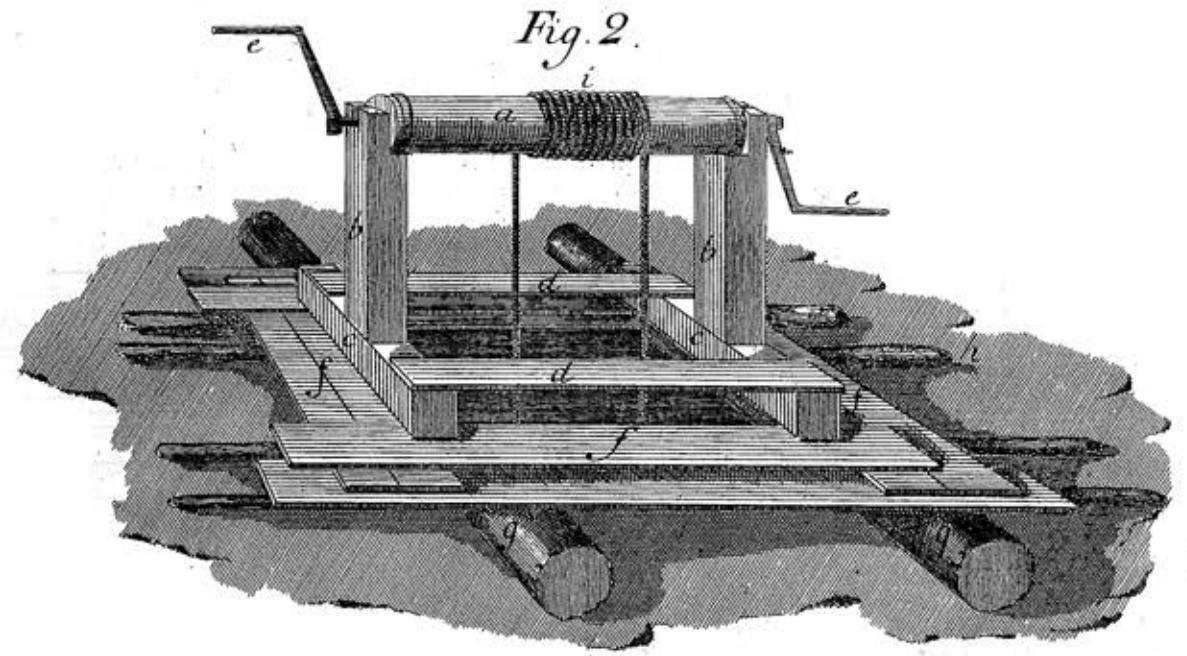
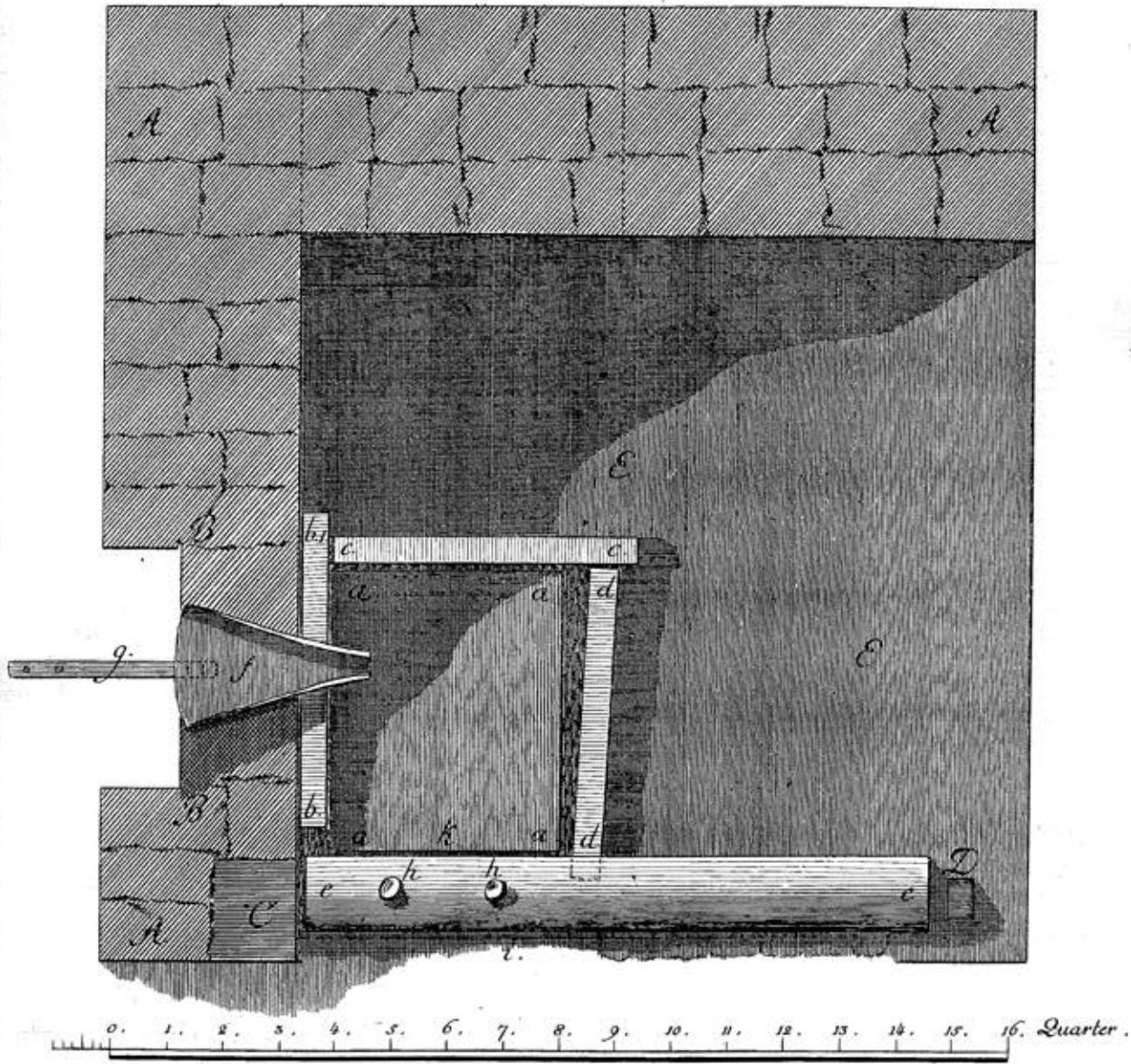

Fig. 1.



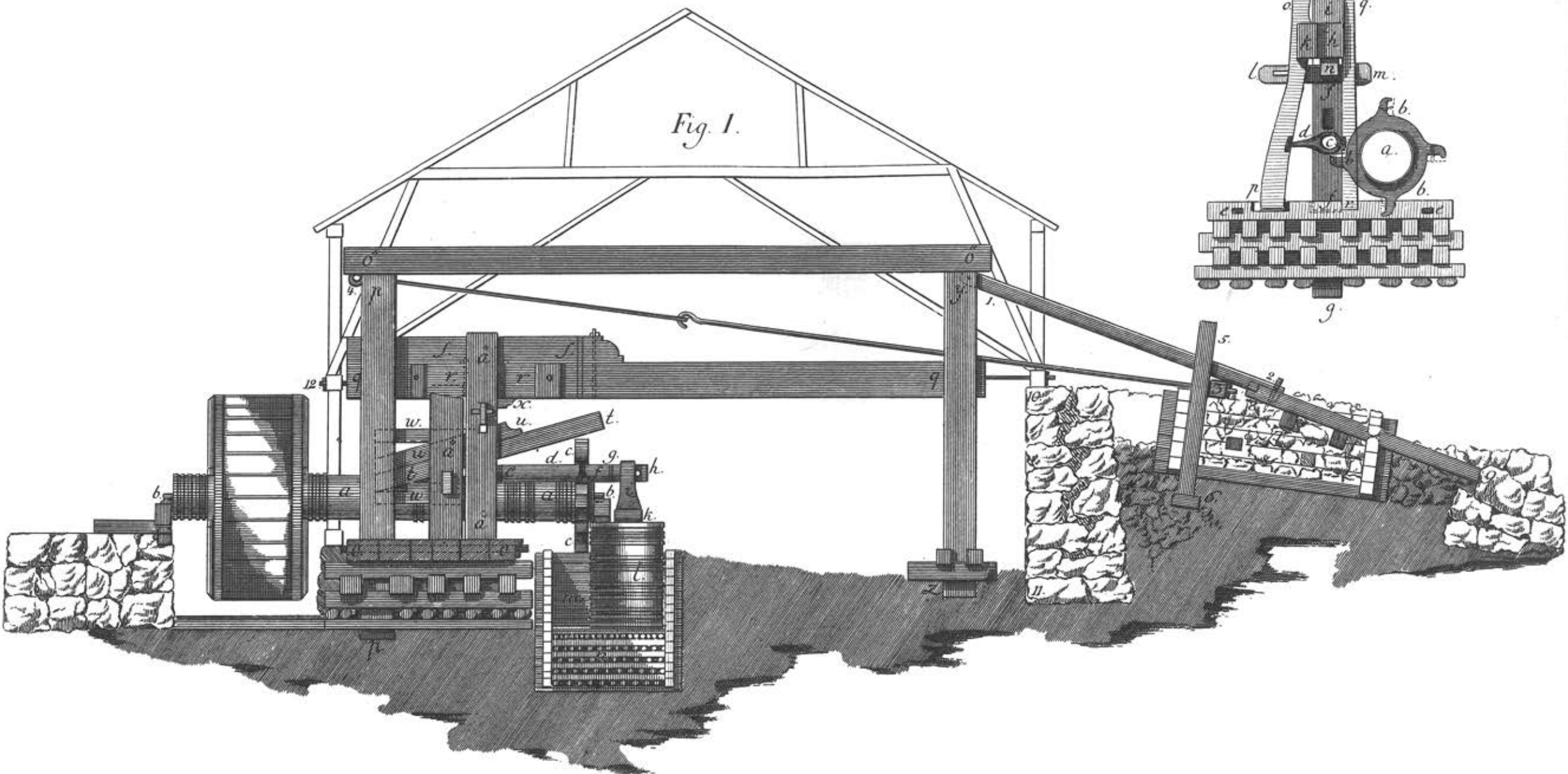

Fig. 1.

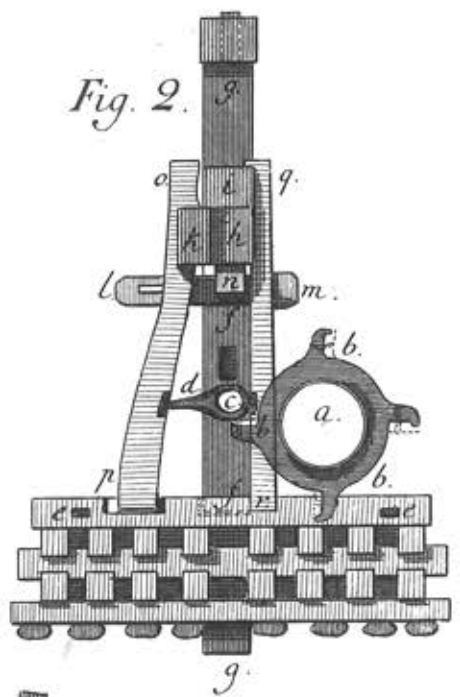
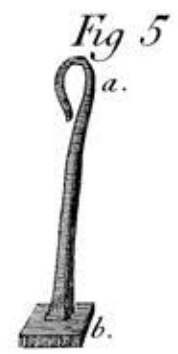
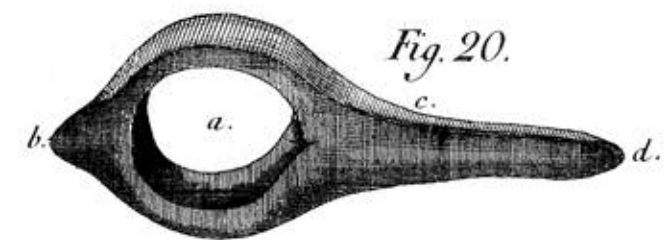
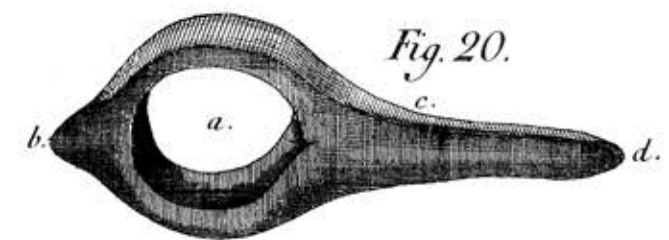
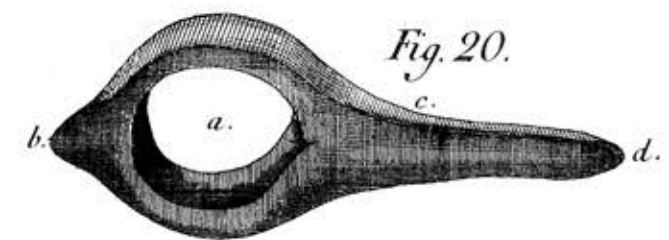
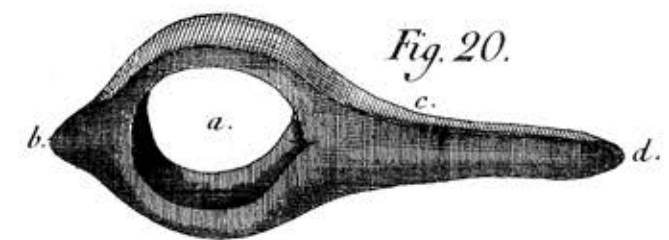
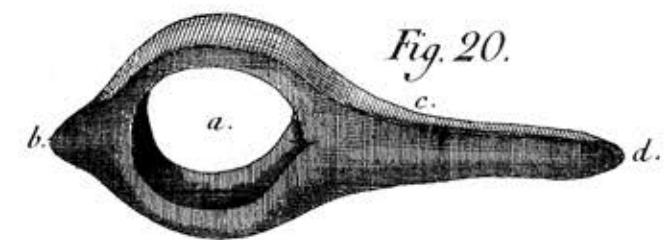
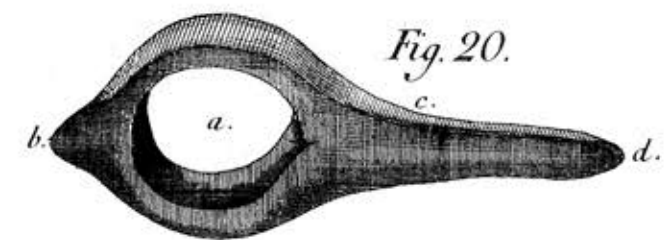
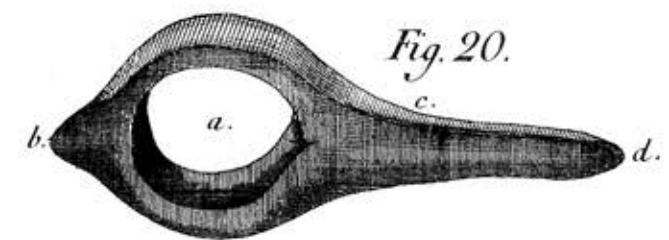
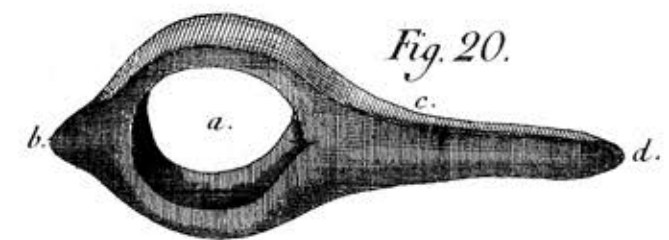
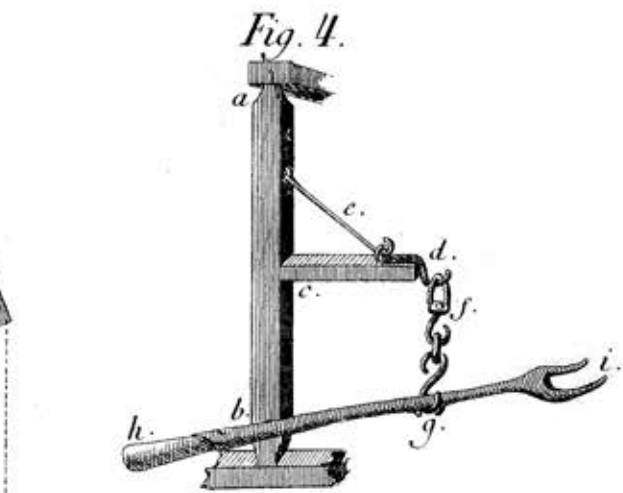
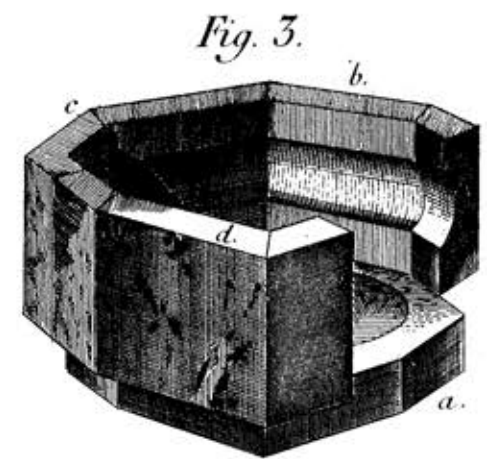
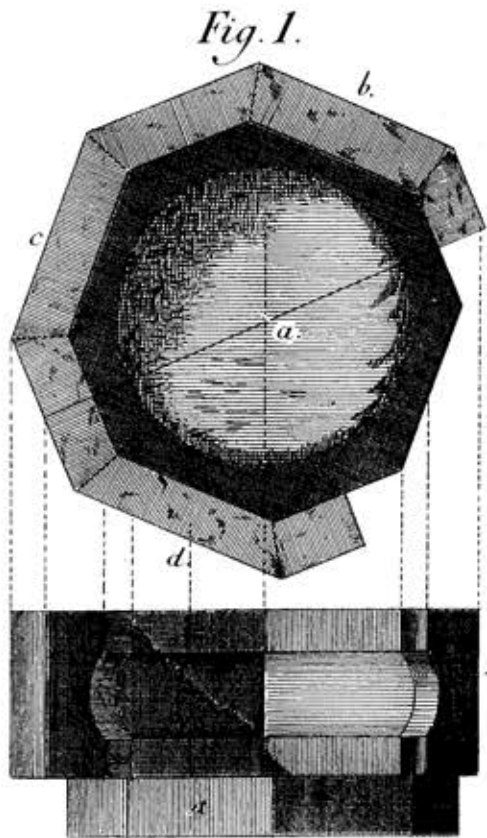
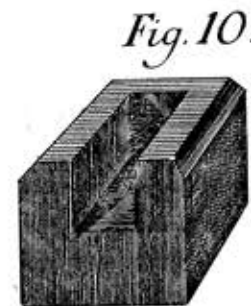
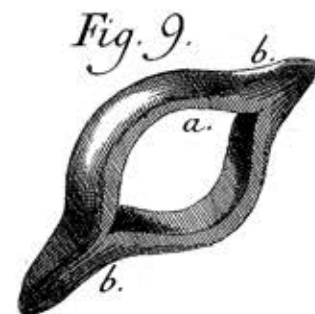
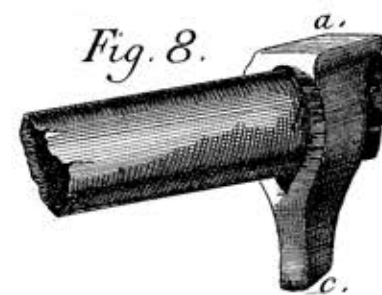
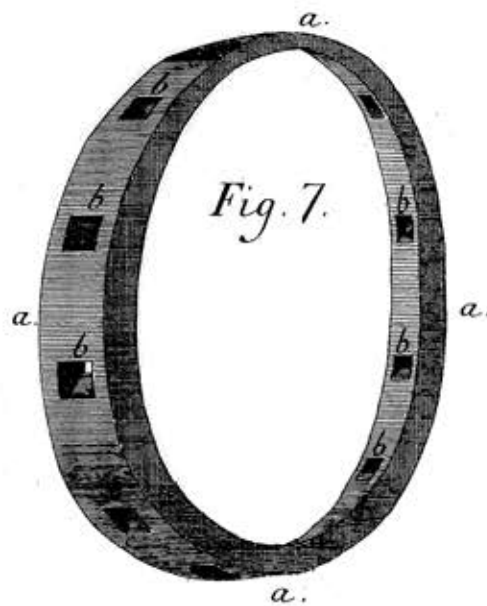
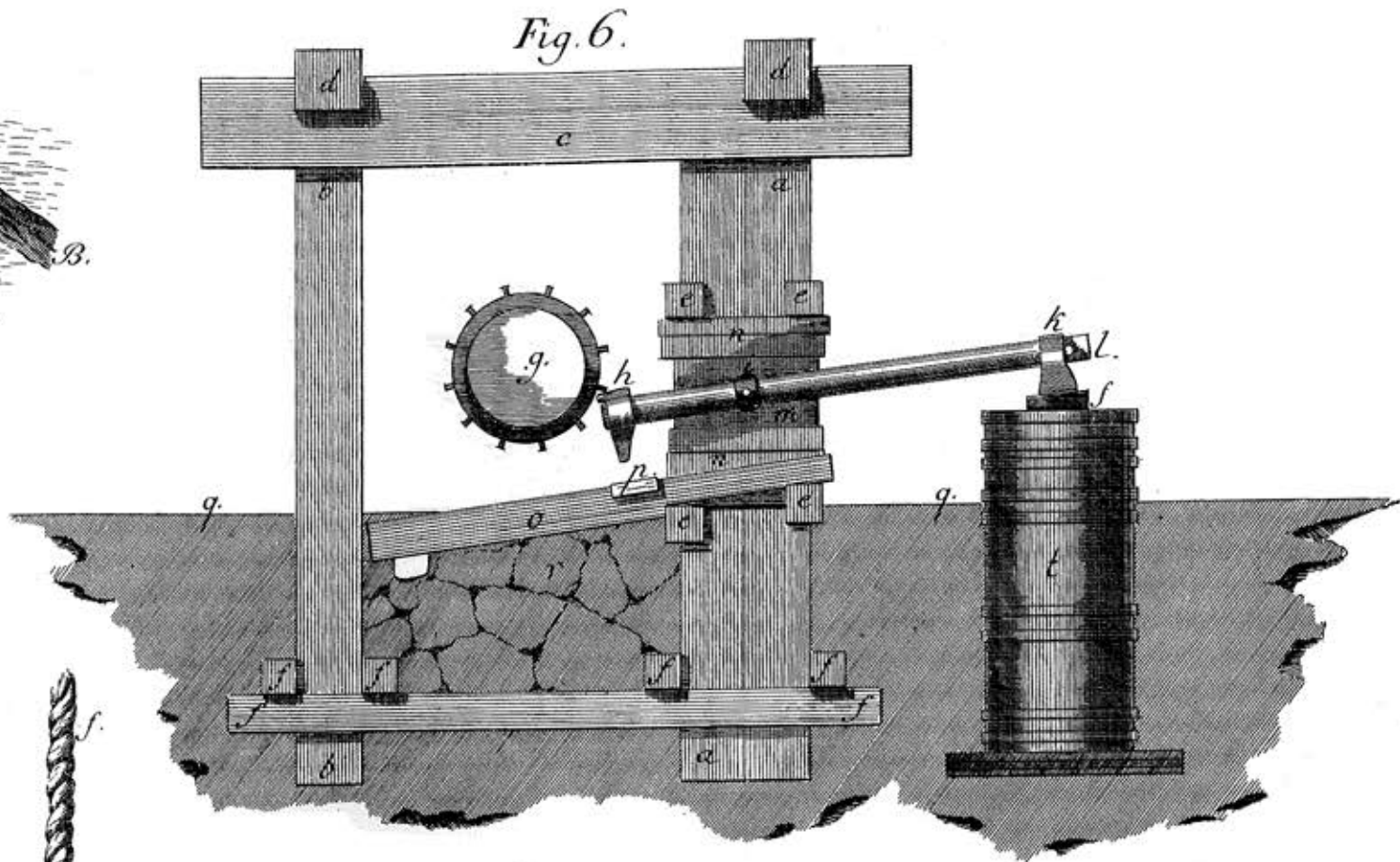
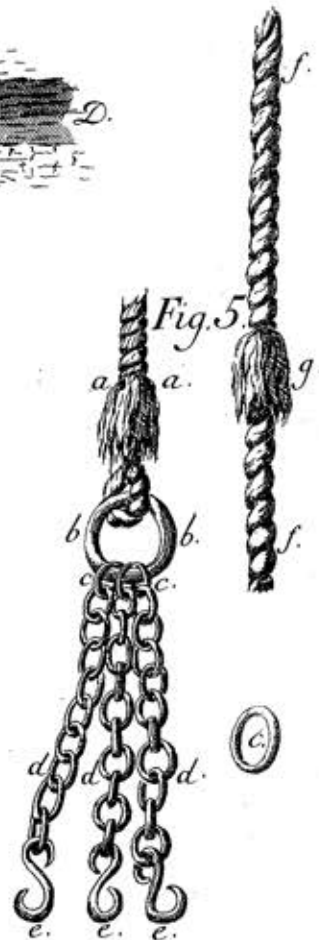
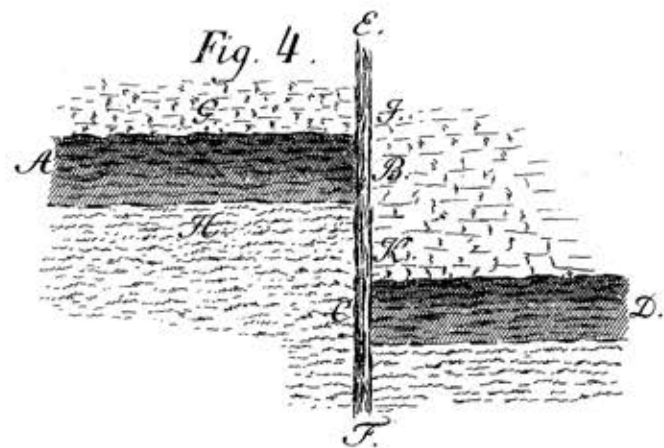
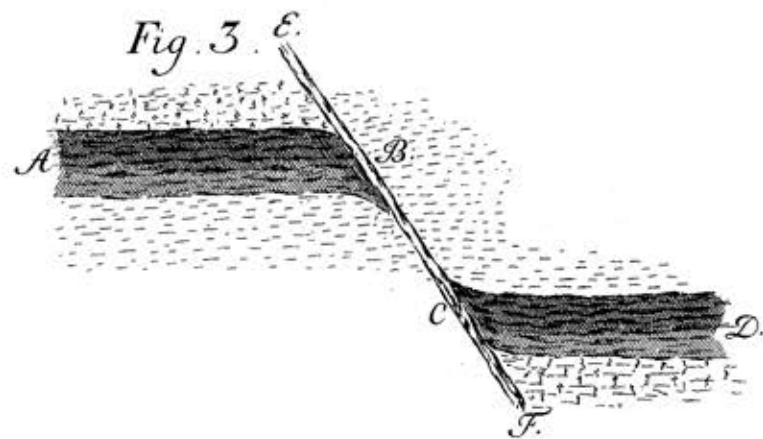
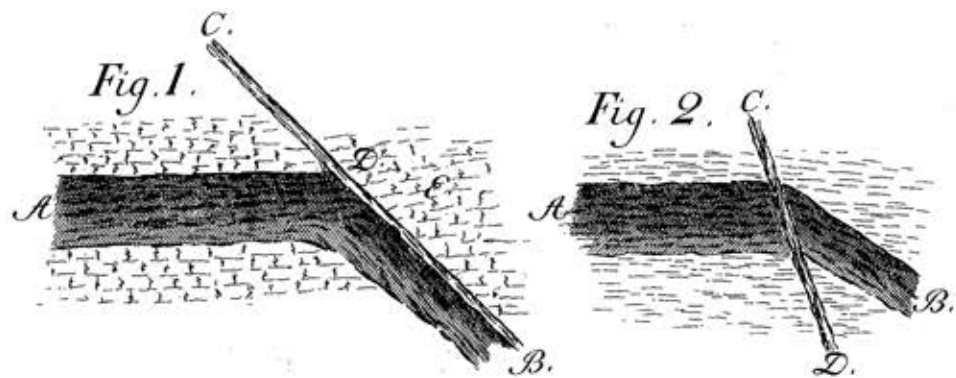

Fig. 2.





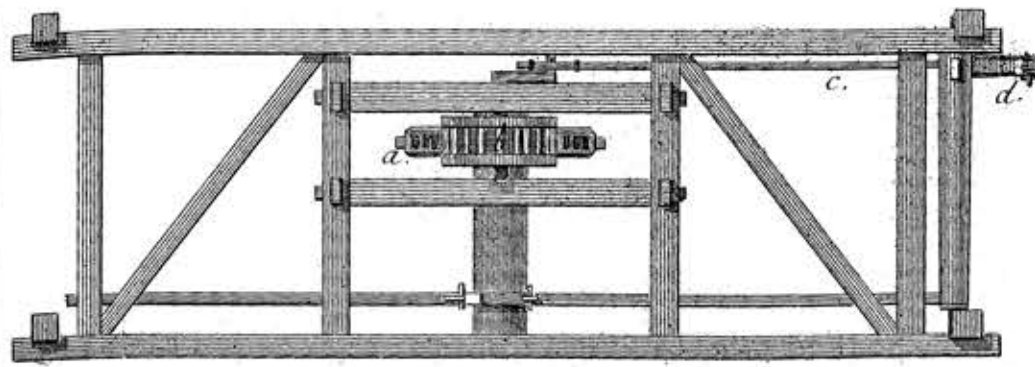

Fig. 2.

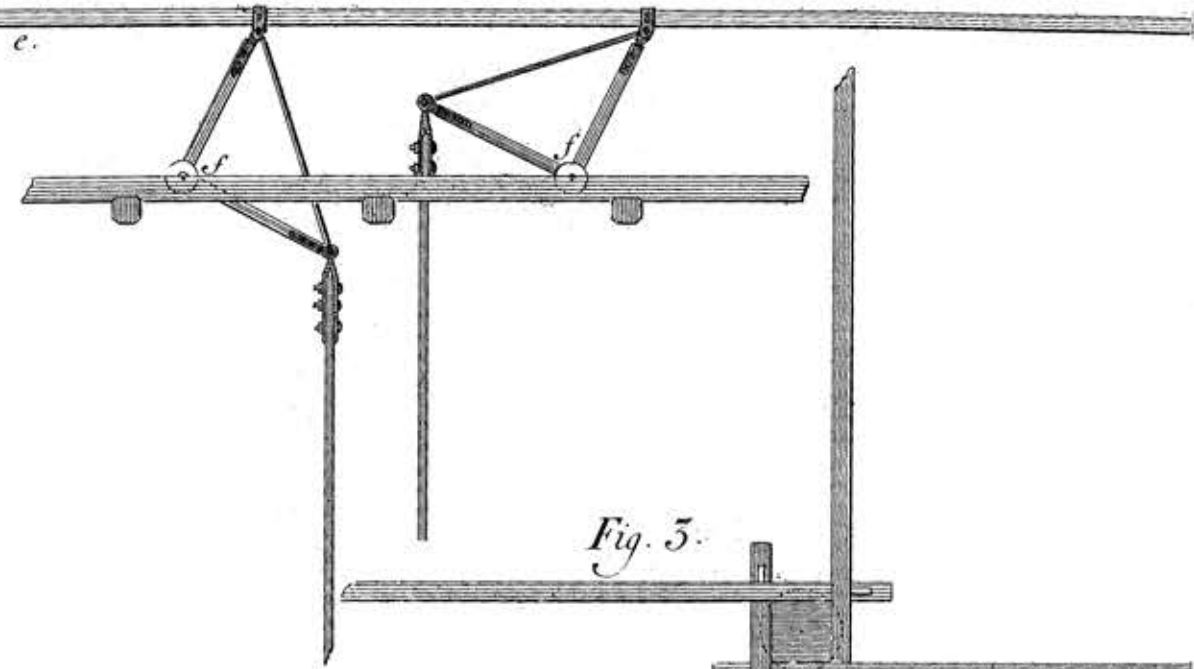

Fig. 5.

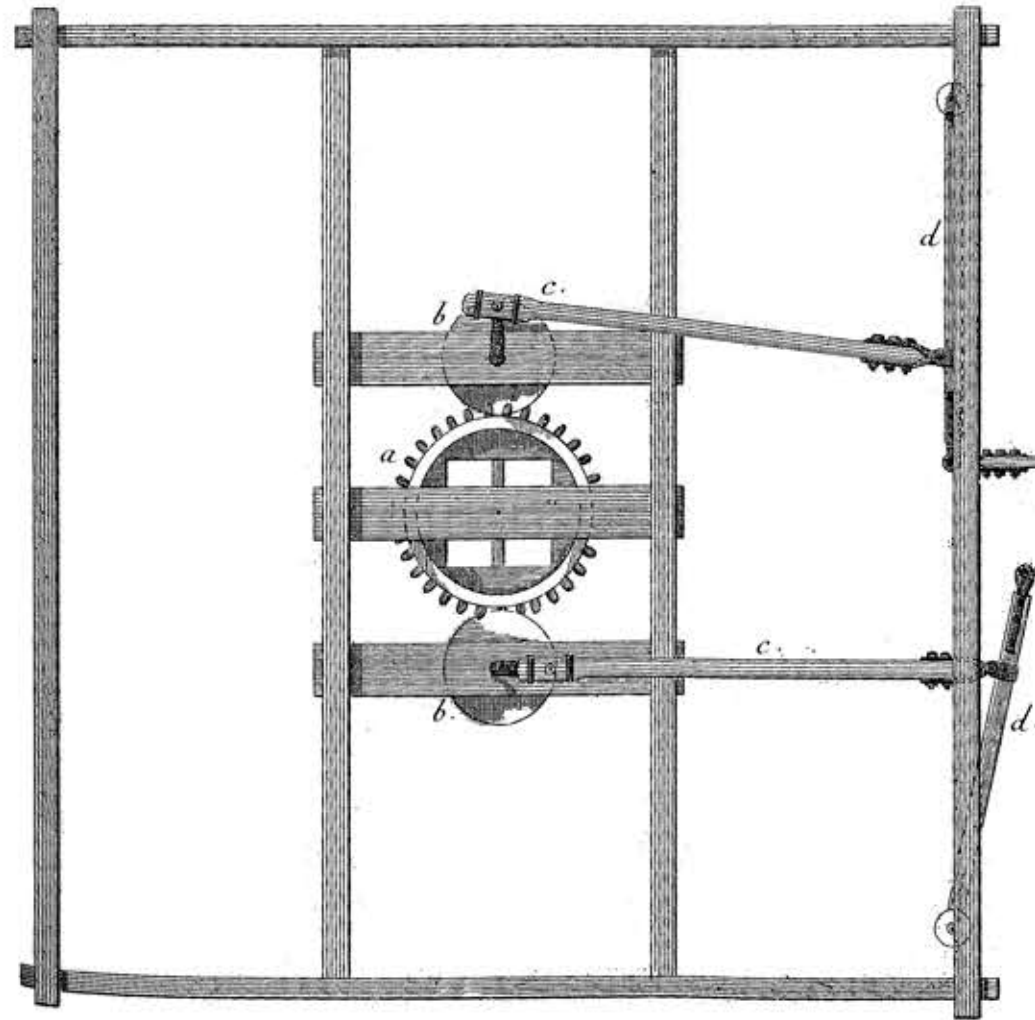
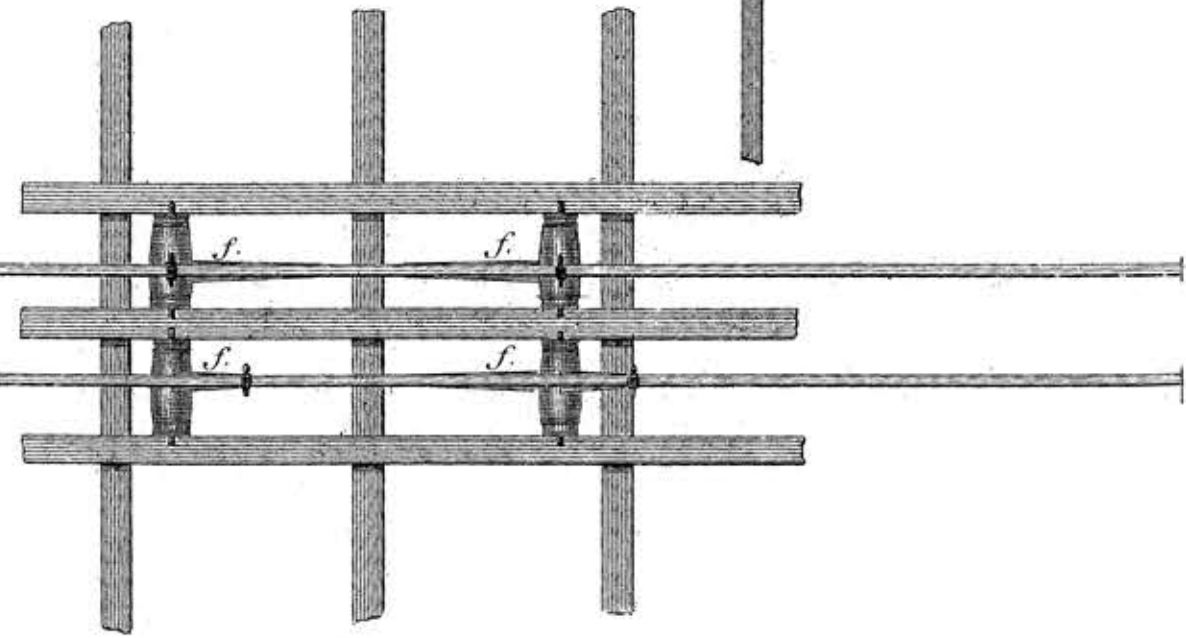

Fig. 1.



L.
k.
i.
h.
g.
f.
e.
d.
c.
b.
a.

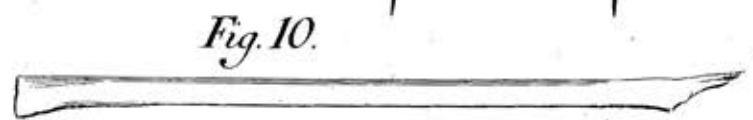
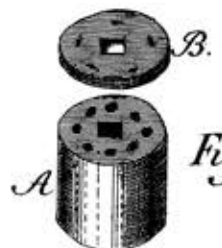
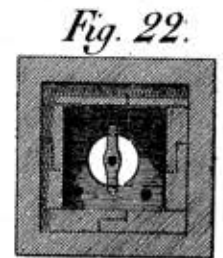
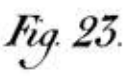
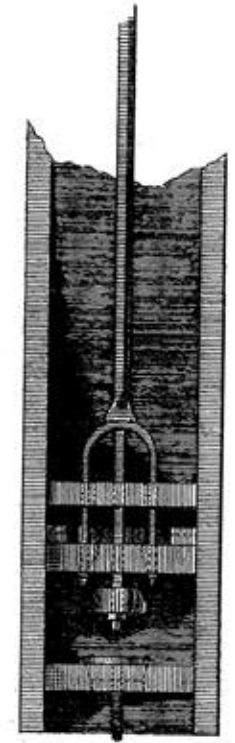
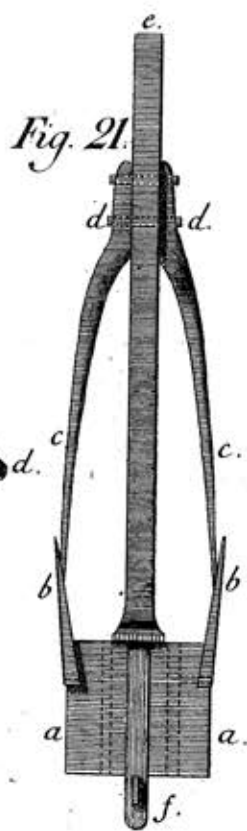
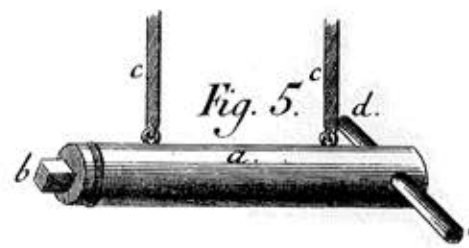
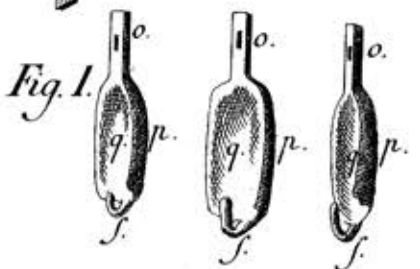
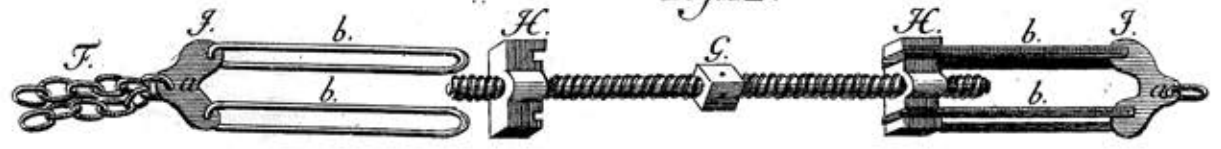
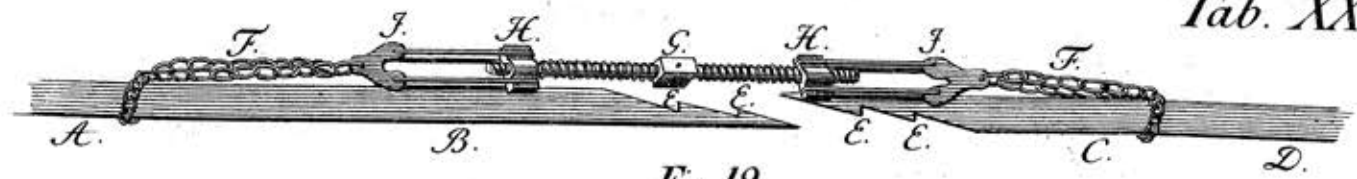
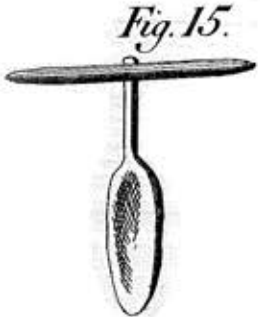
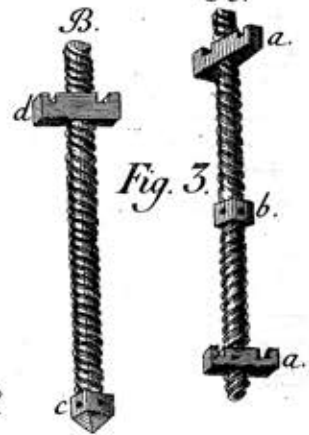
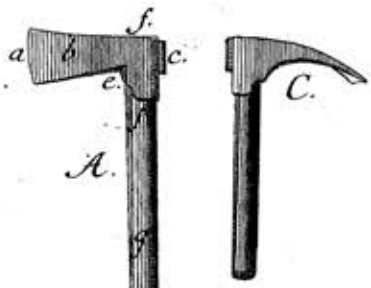

Fig. 1.

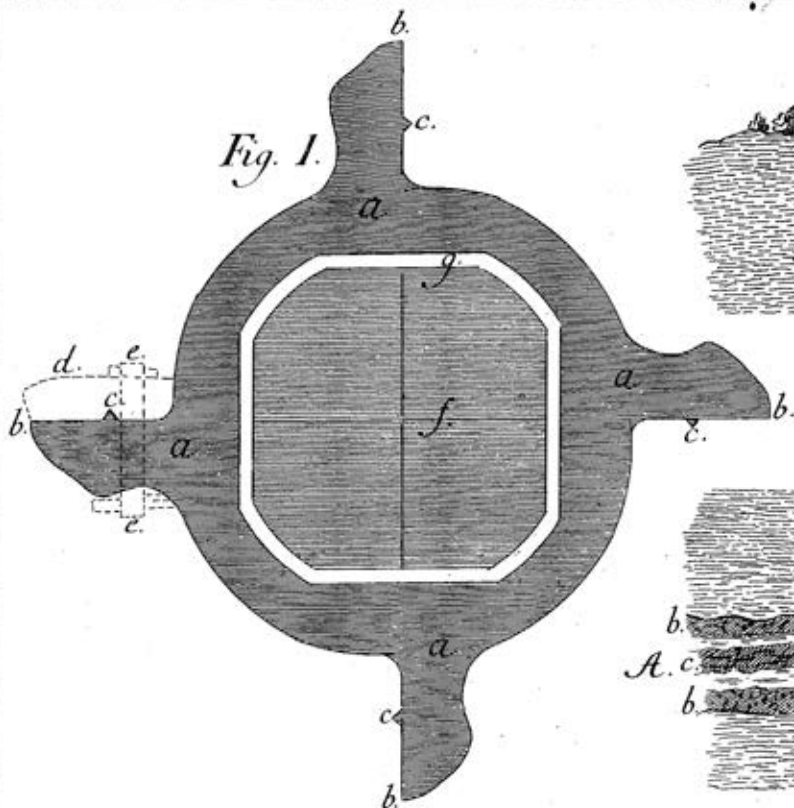

Fig. 2.

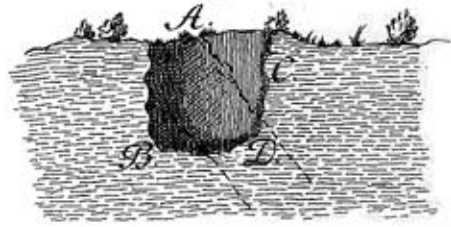

Fig. 3.

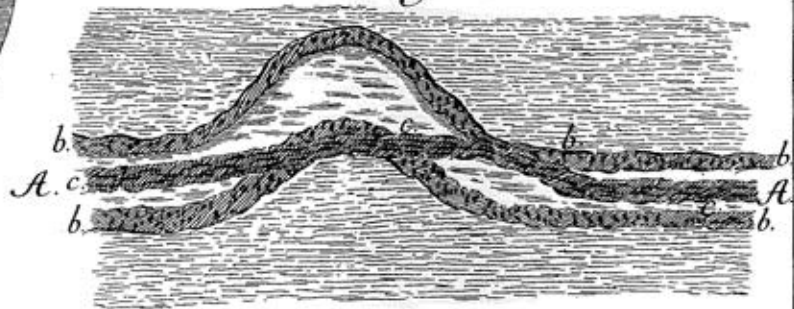

Fig. 4.

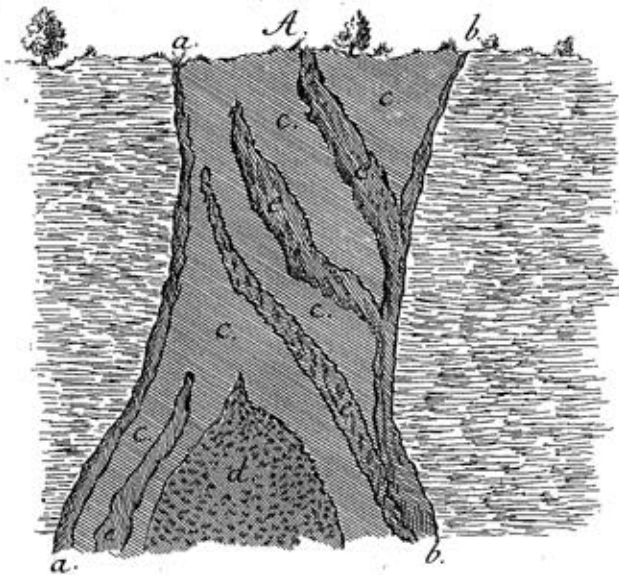

Fig. 5.



0. 1. 2. 3. 4. 5. 6. 7. 8. 9. 10. 11. 12. 13. 14. 15. Quarter.

Fig. 1.



Fig. 2.



Fig. 3.



Fig. 4.

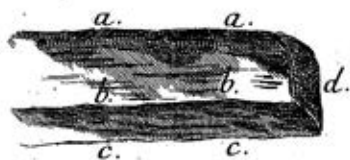

Fig. 5.





Fig. 5.

Fig. 2.

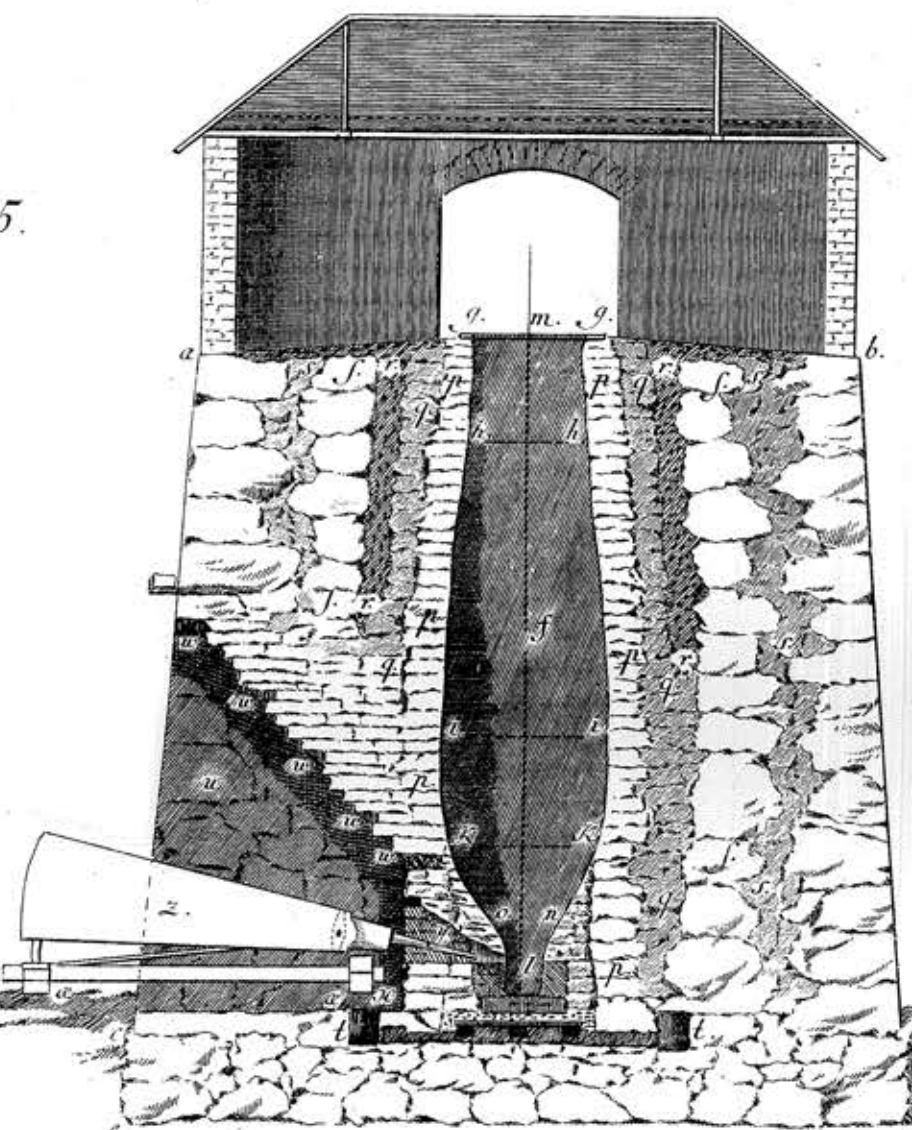
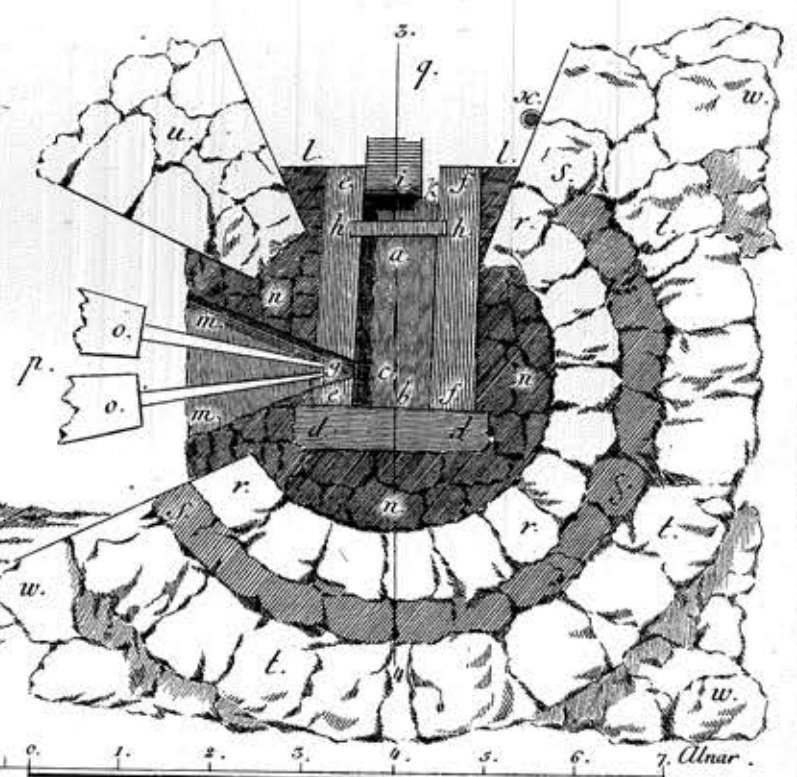
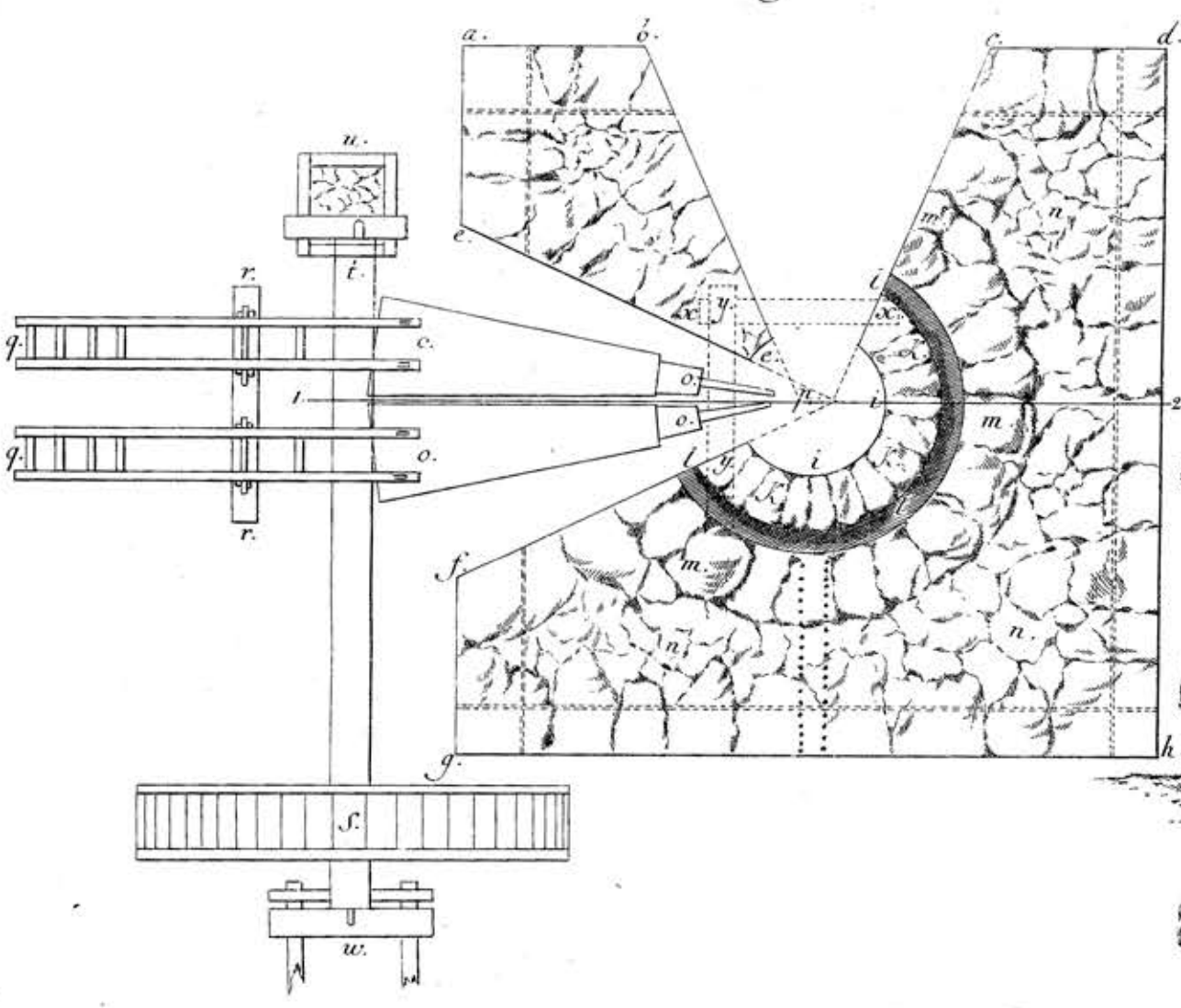

Fig. 1.

Fig. 3.



№. 2.



№. 1.

Fig. 4.

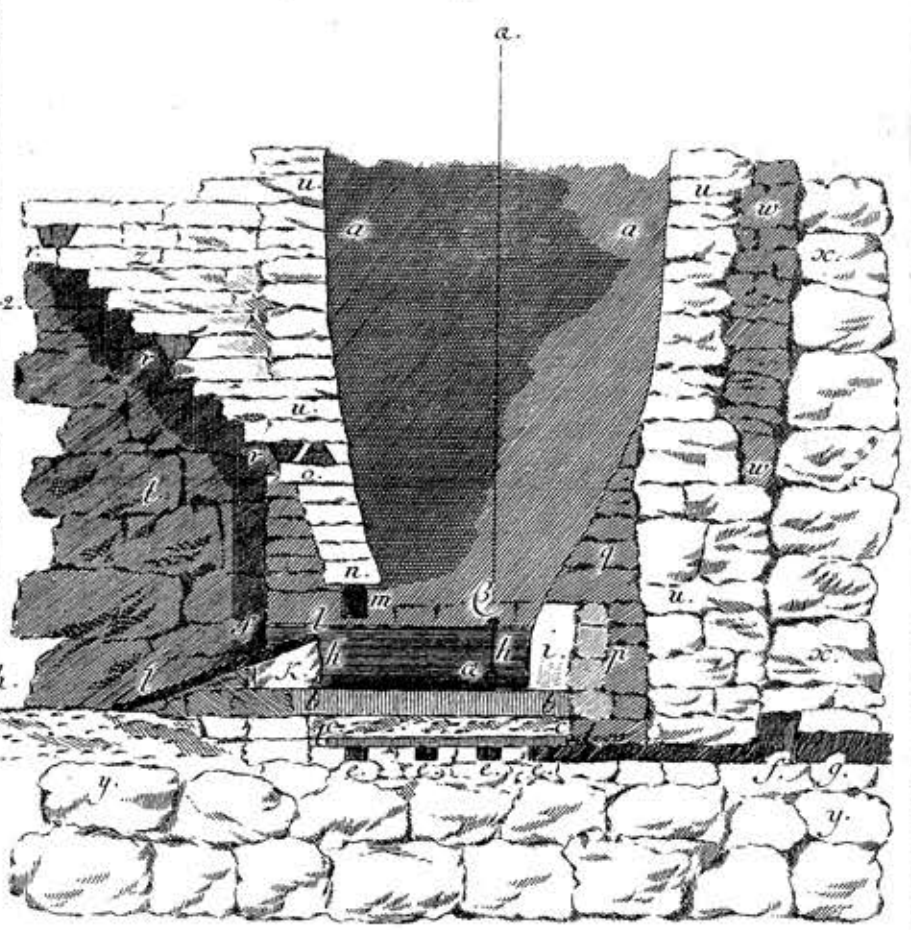

Fig. 5.

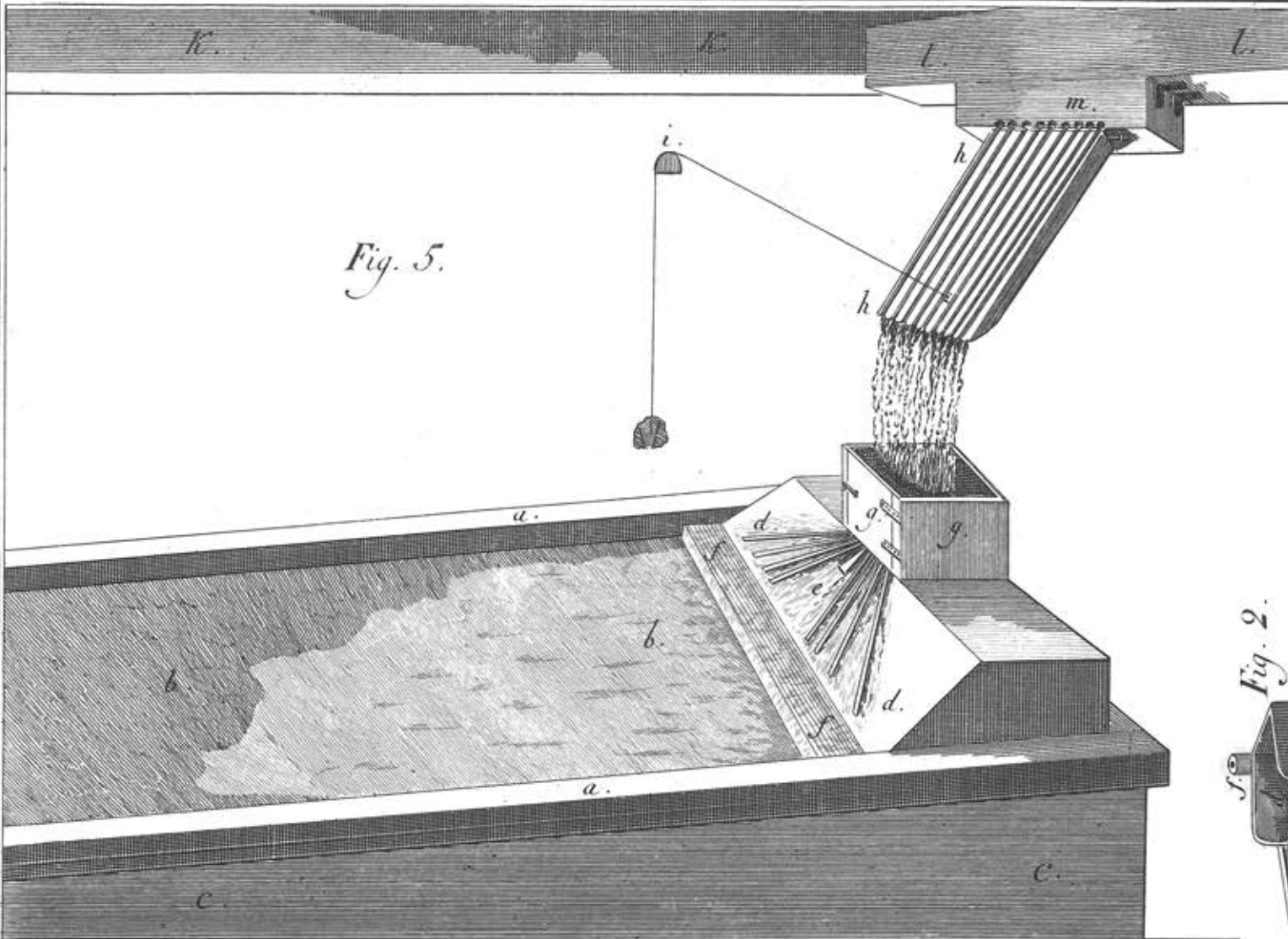

Fig. 2.

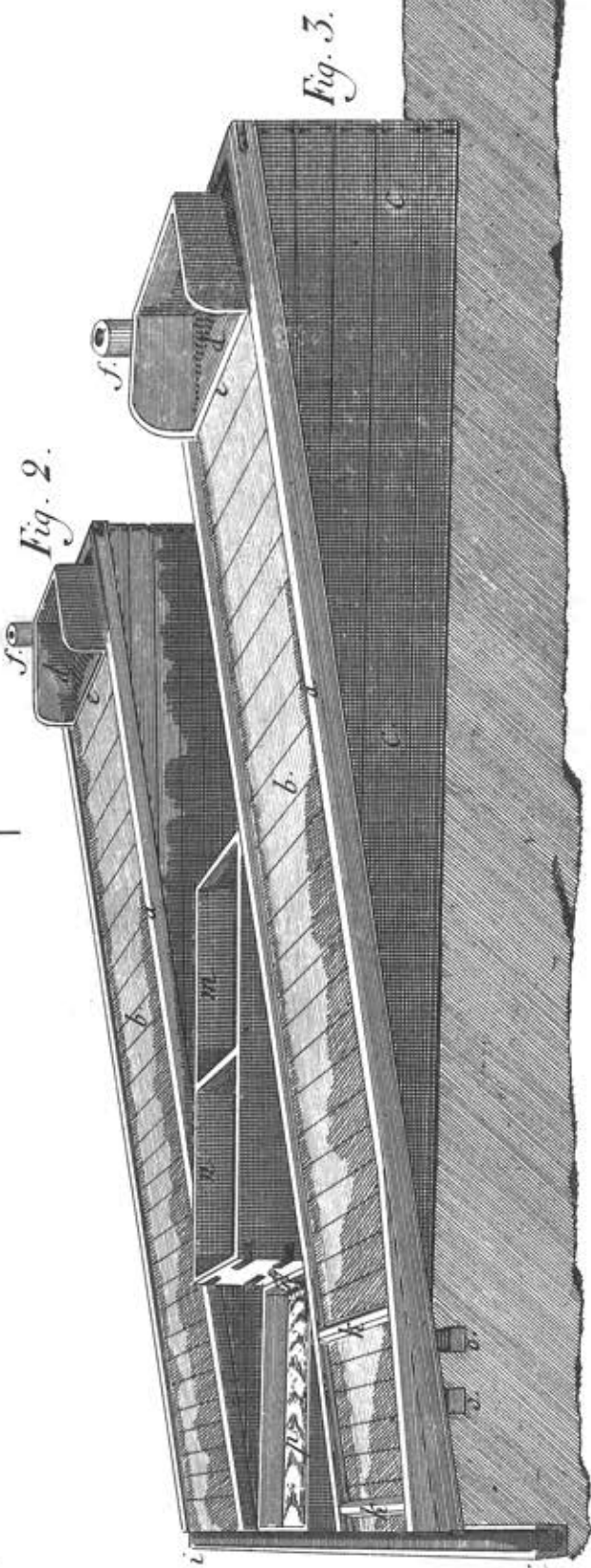

Fig. 3.

Fig. 1.

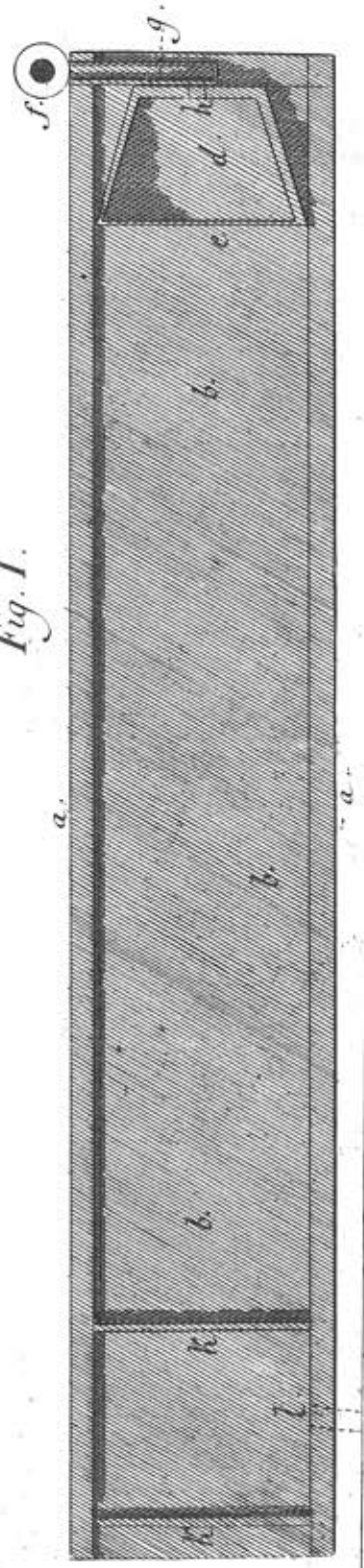

Fig. 4.

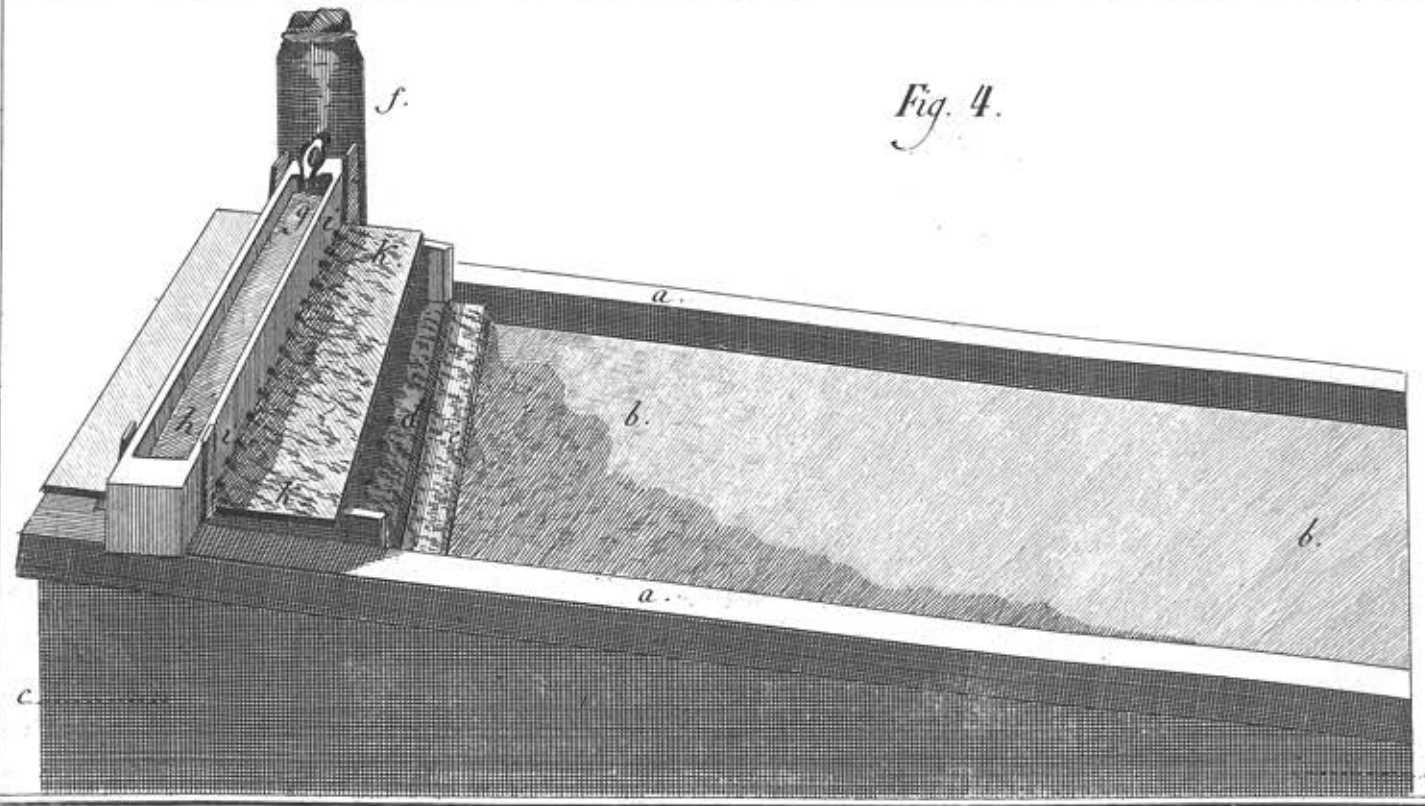

Fig. 5.

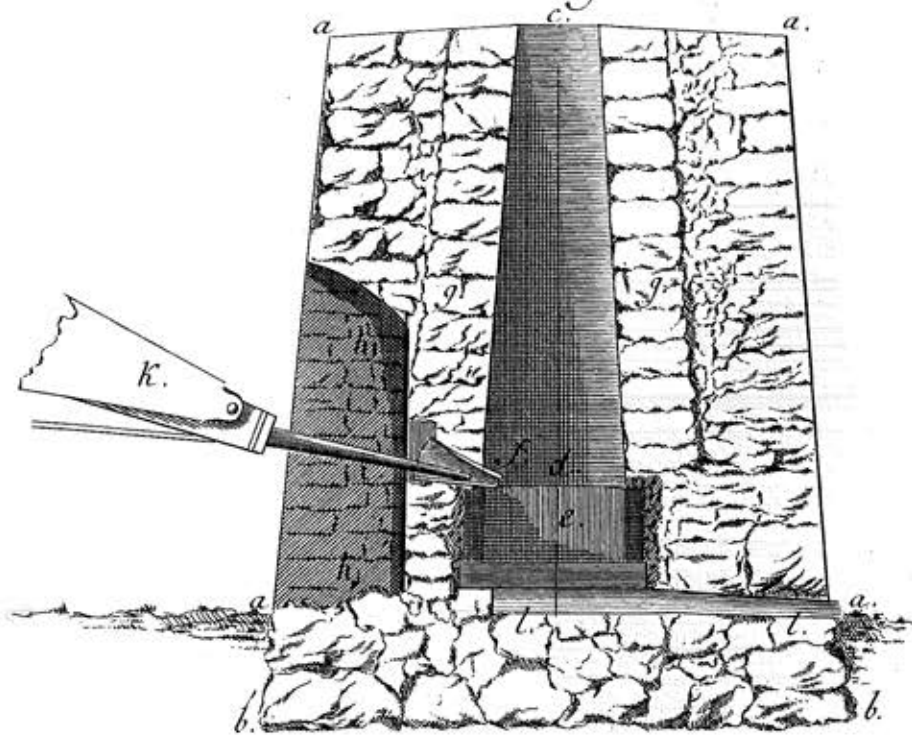

Fig. 3.

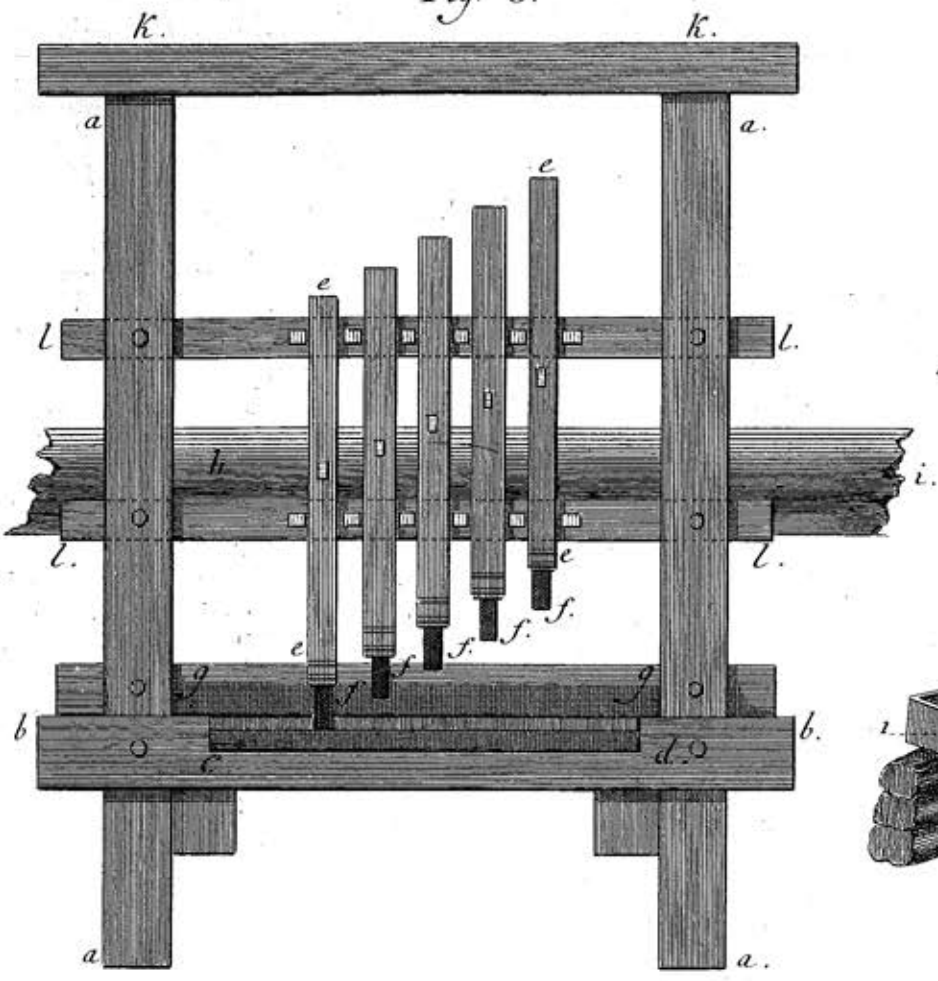

Fig. 1.

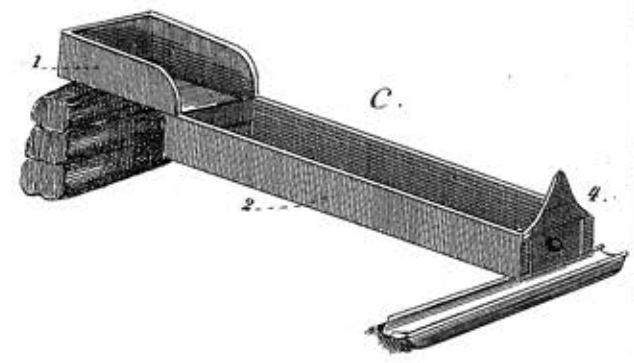
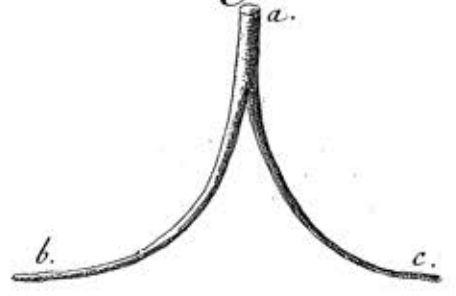

Fig. 2.

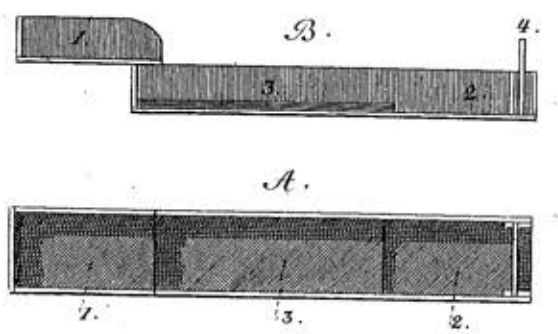

Fig. 6.

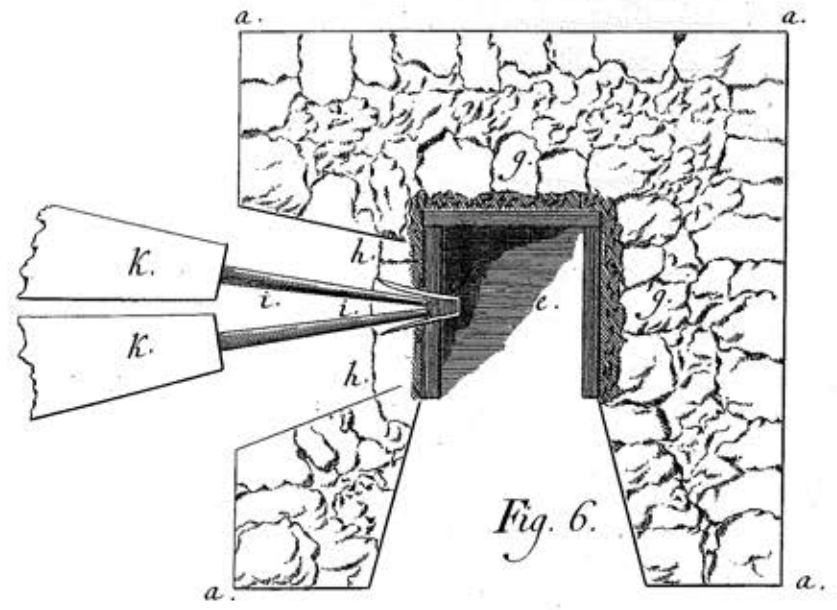
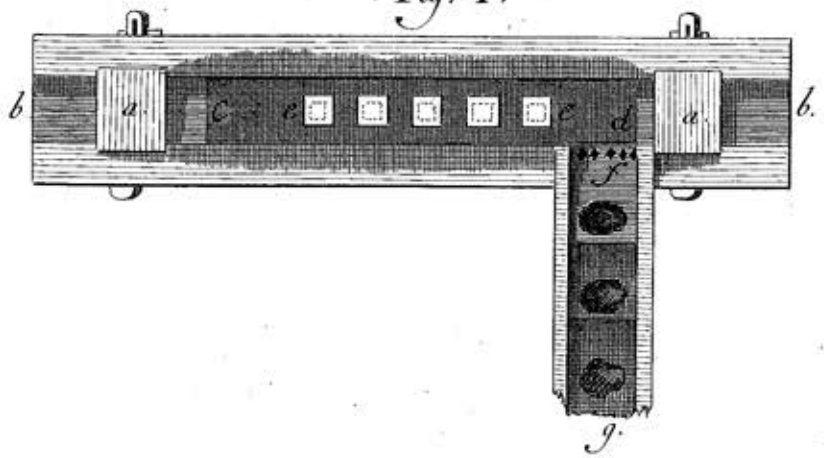

Fig. 4.



0. 1. 2. 3. 4. 5. 6. Alnar.

0. 1. 2. 3. 4. 5. 6. Alnar.

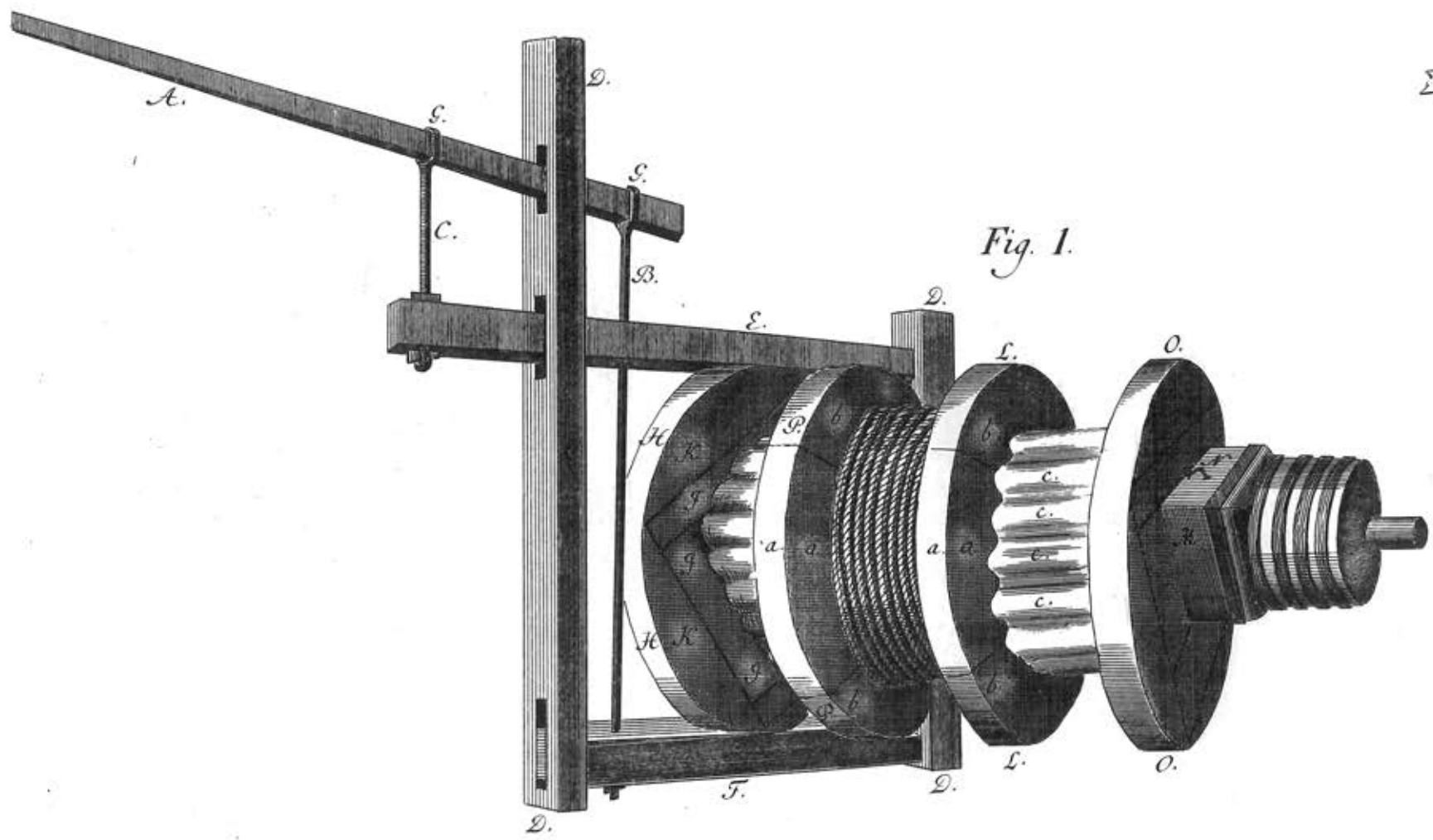

Fig. 1.

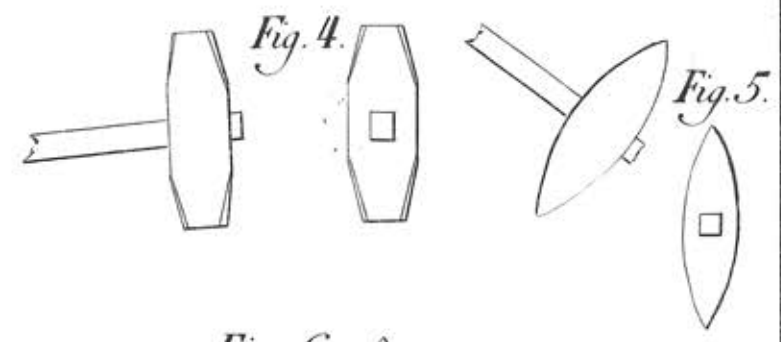

Fig. 4.

Fig. 5.

Fig. 6.

Fig. 7.

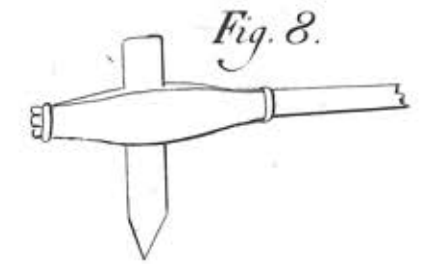

Fig. 8.



Fig. 9.

Fig. 10.

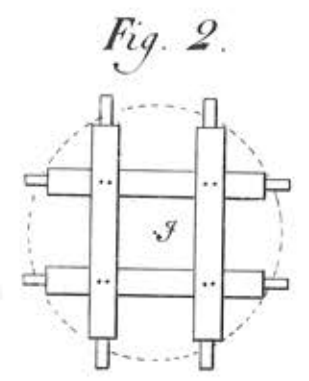
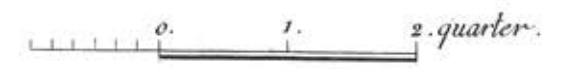

Fig. 2.

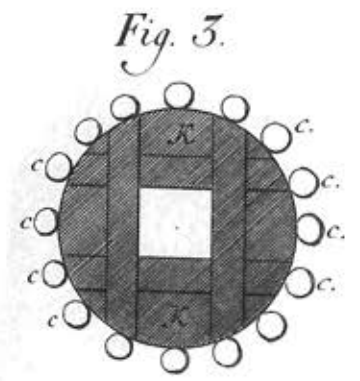

Fig. 3.

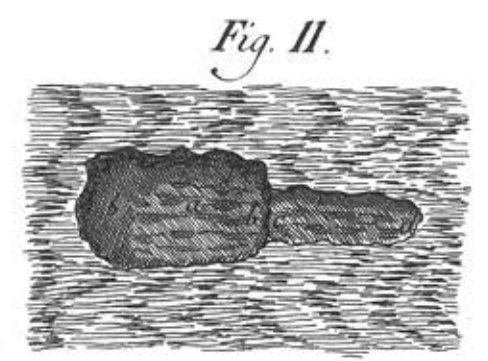

Fig. 11.

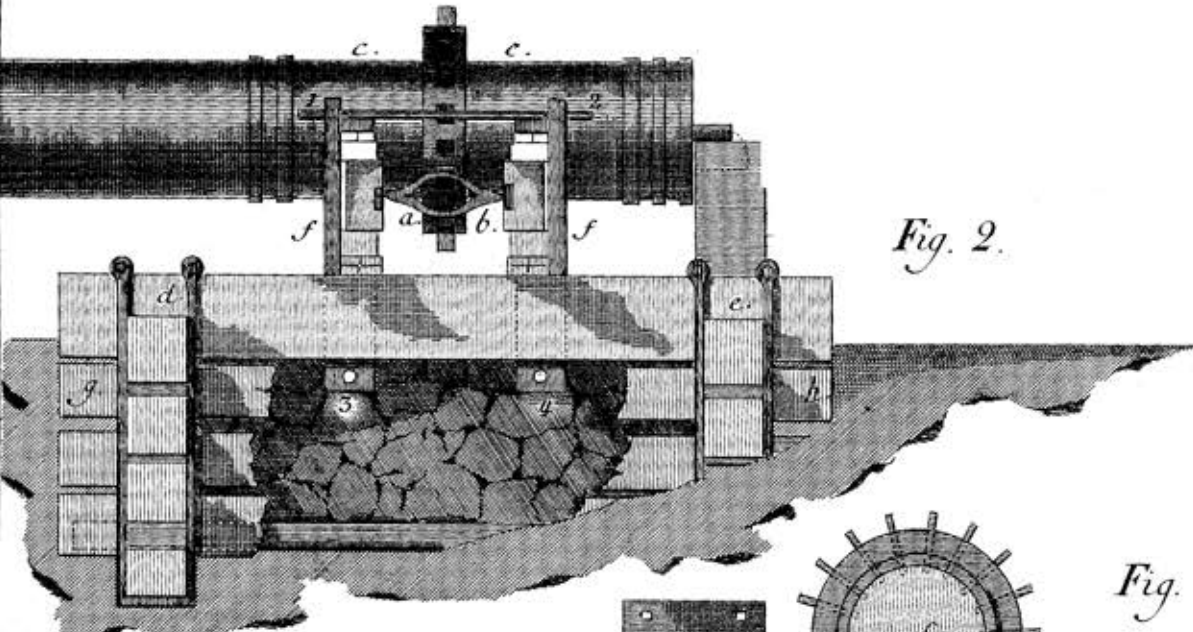

Fig. 2.

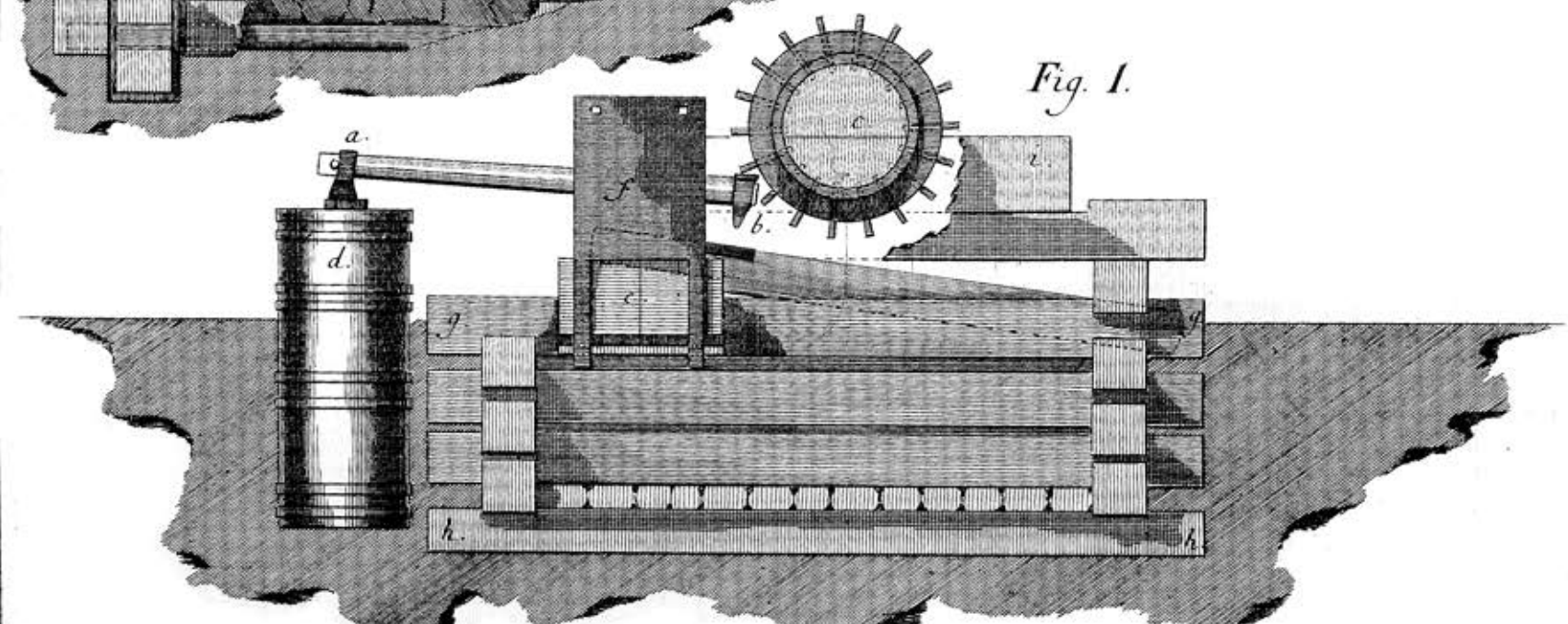

Fig. 1.

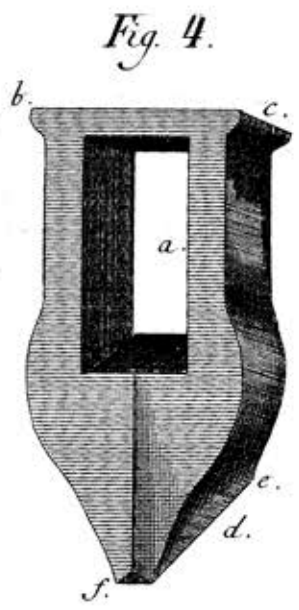

Fig. 4.

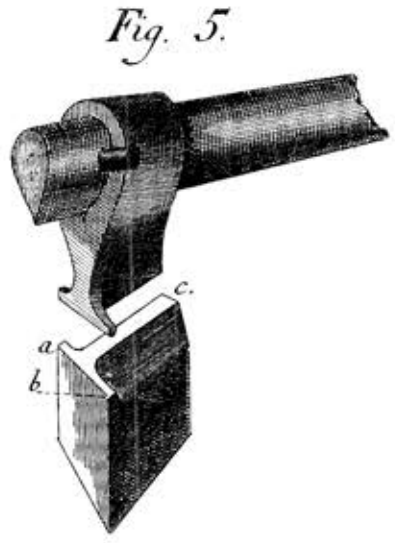

Fig. 5.

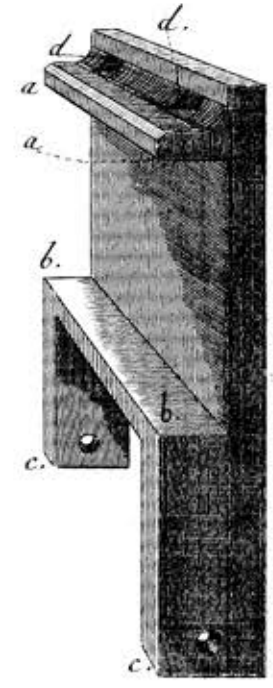

Fig. 3.

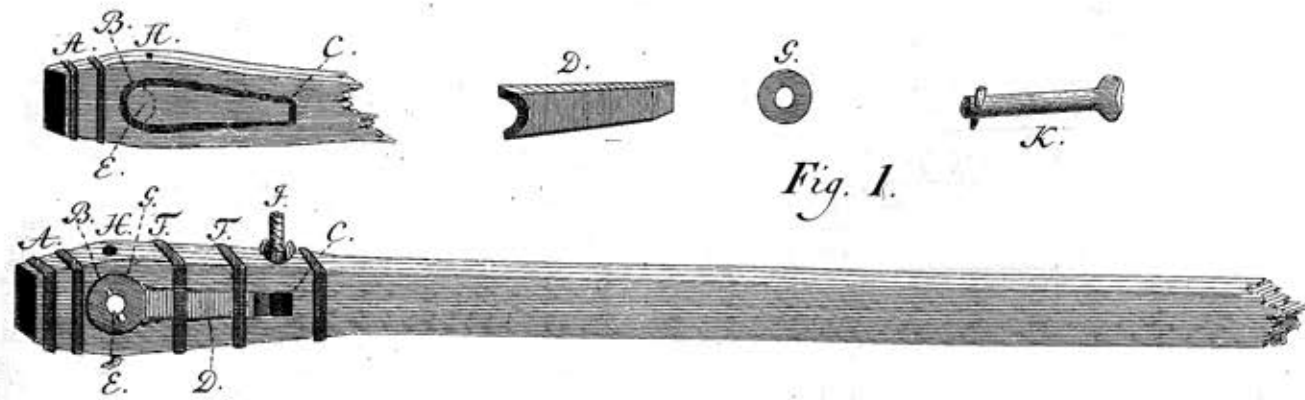

Fig. 1.

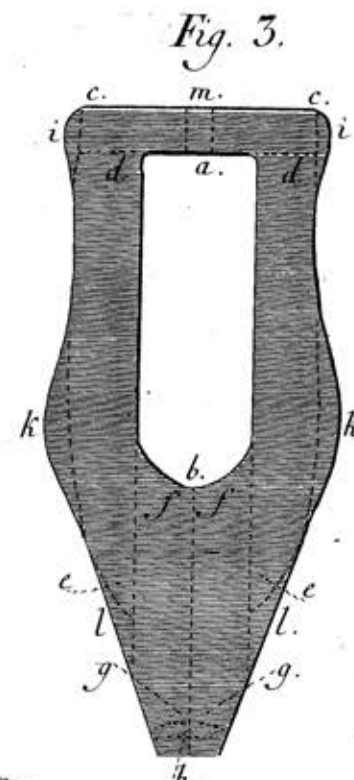

Fig. 3.

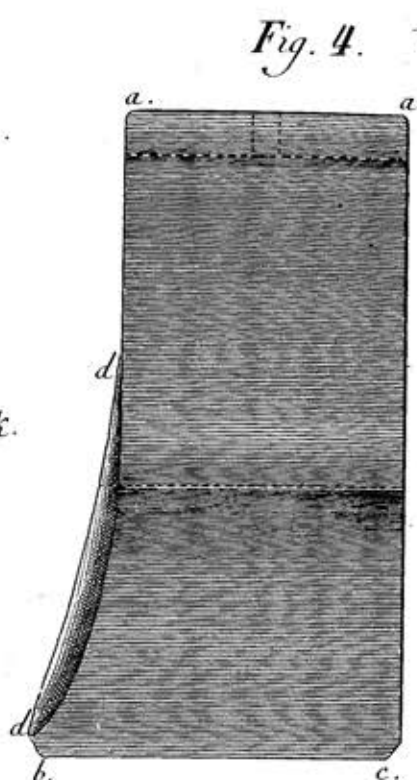

Fig. 4.

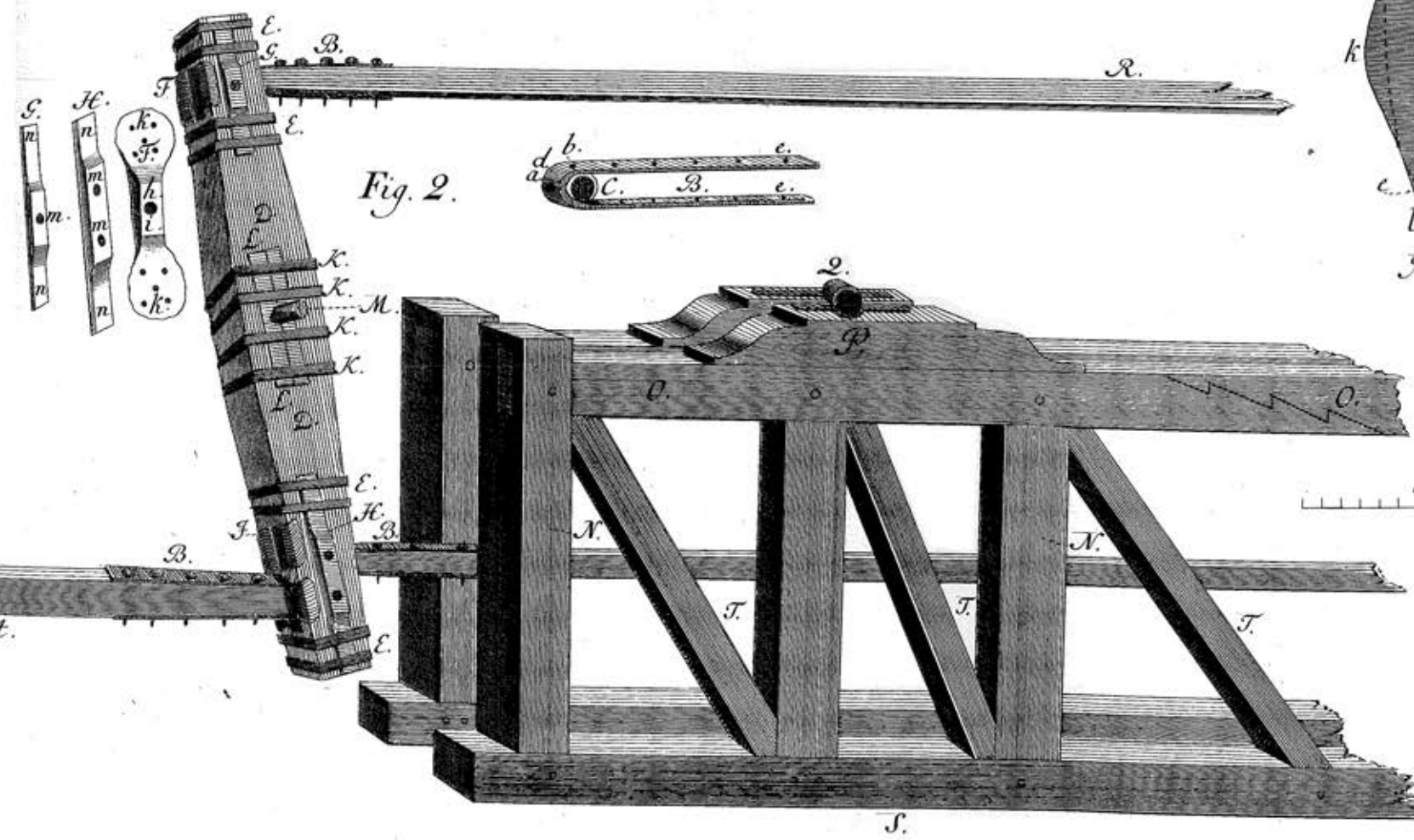

Fig. 2.



Quarter.

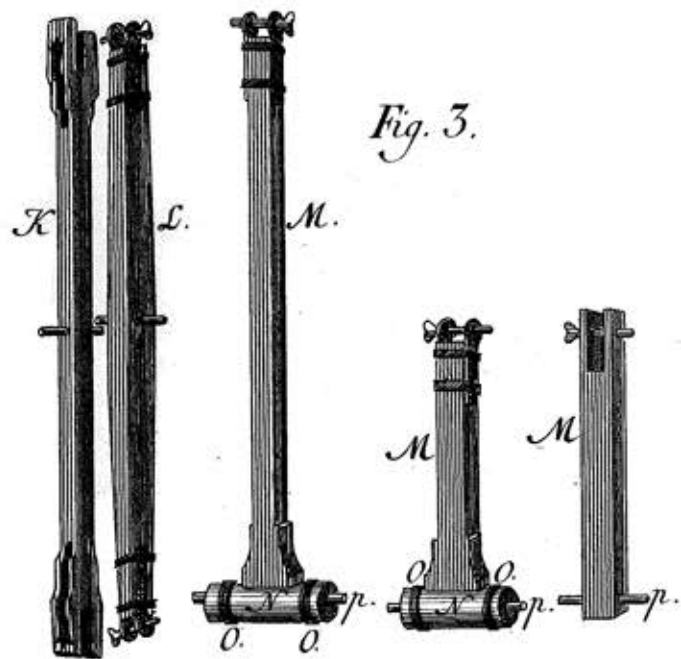
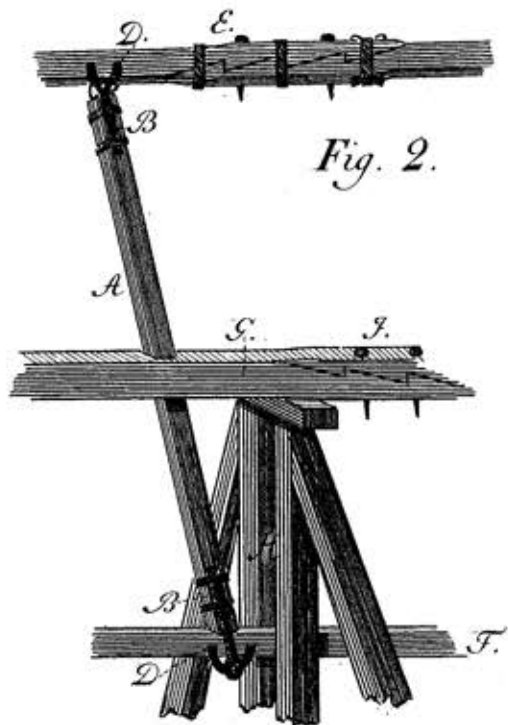
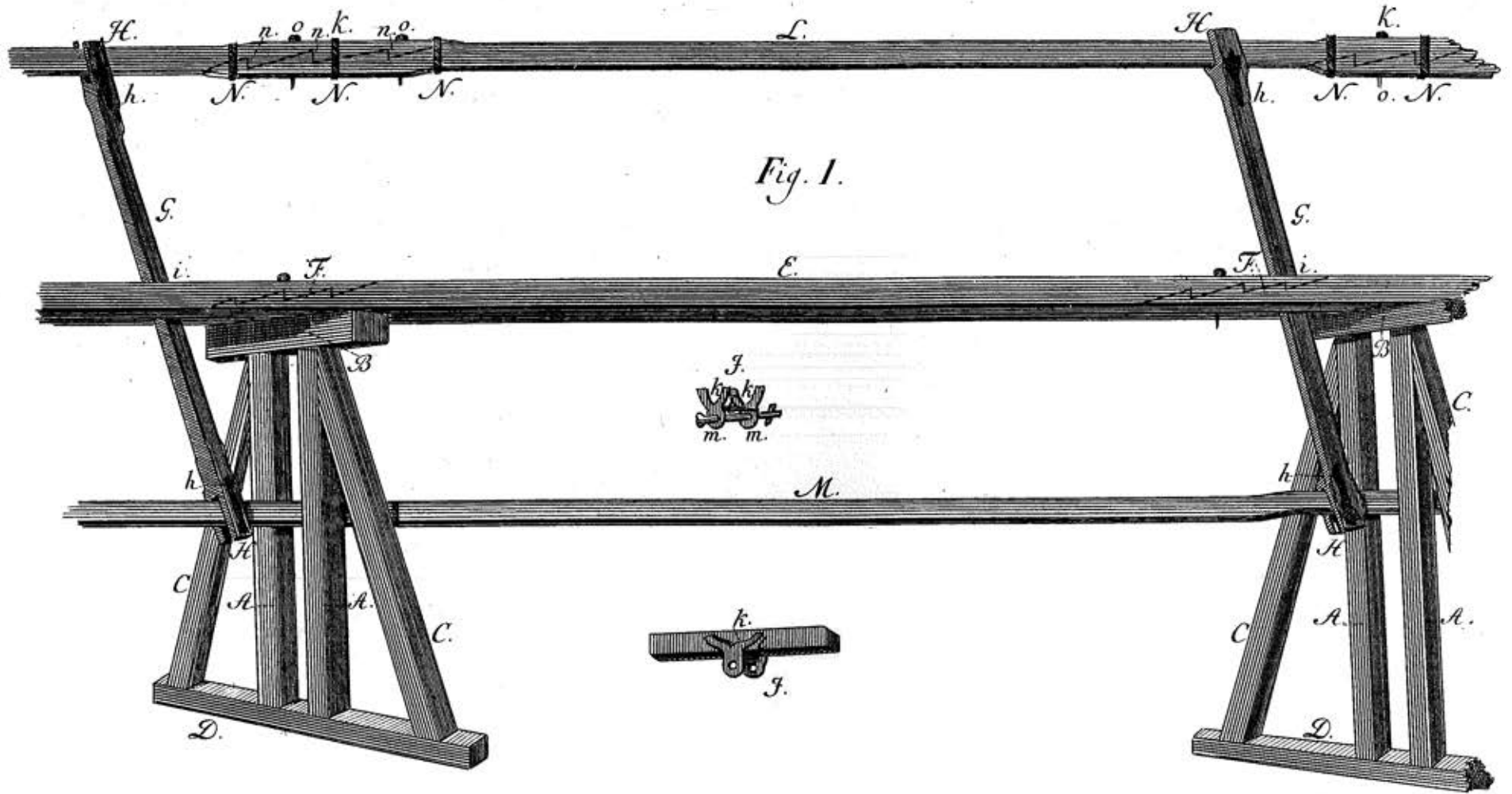

Fig. 1.

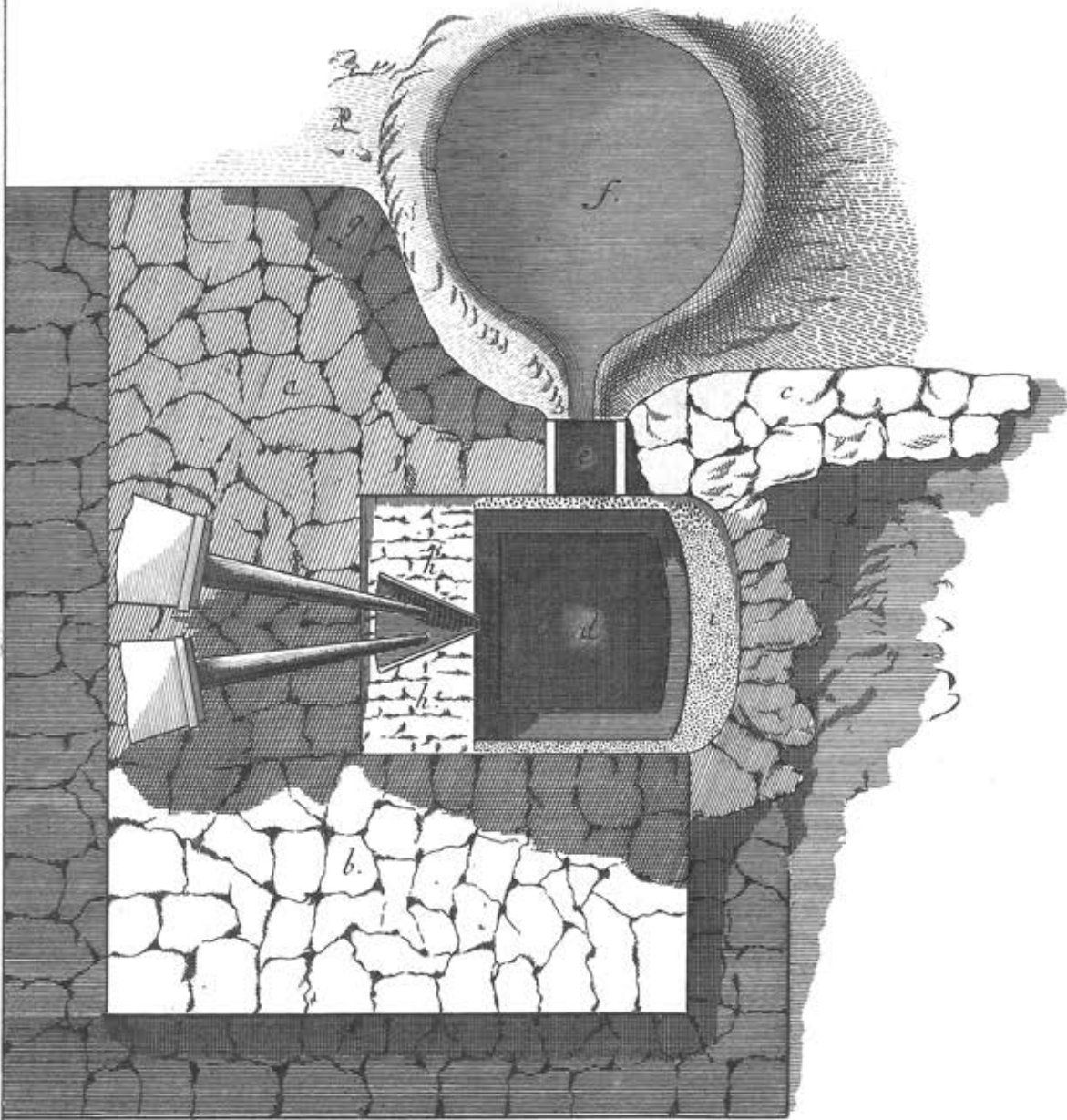
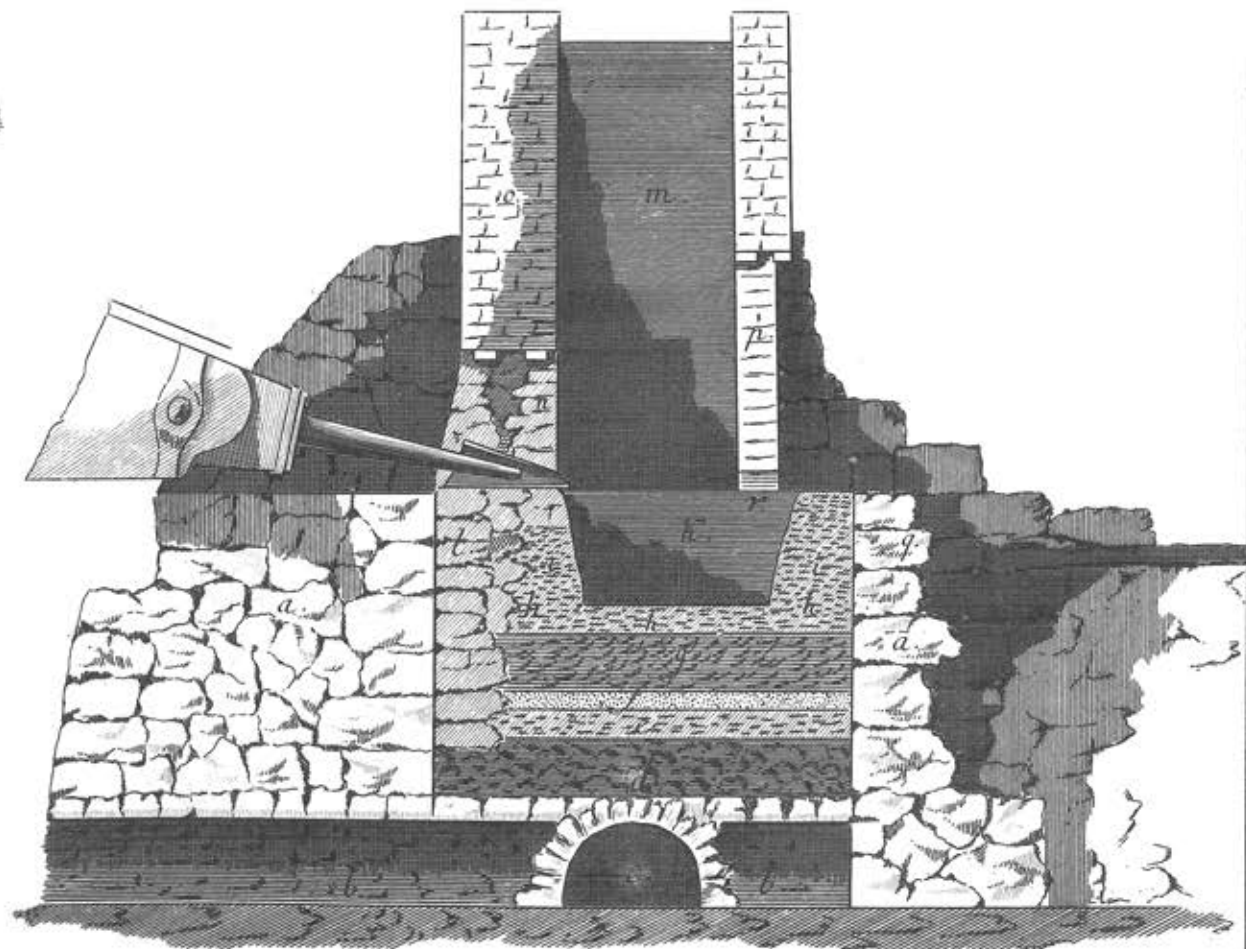

Fig. 2.



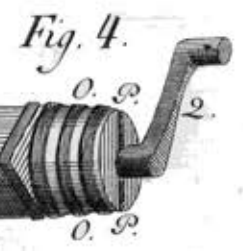
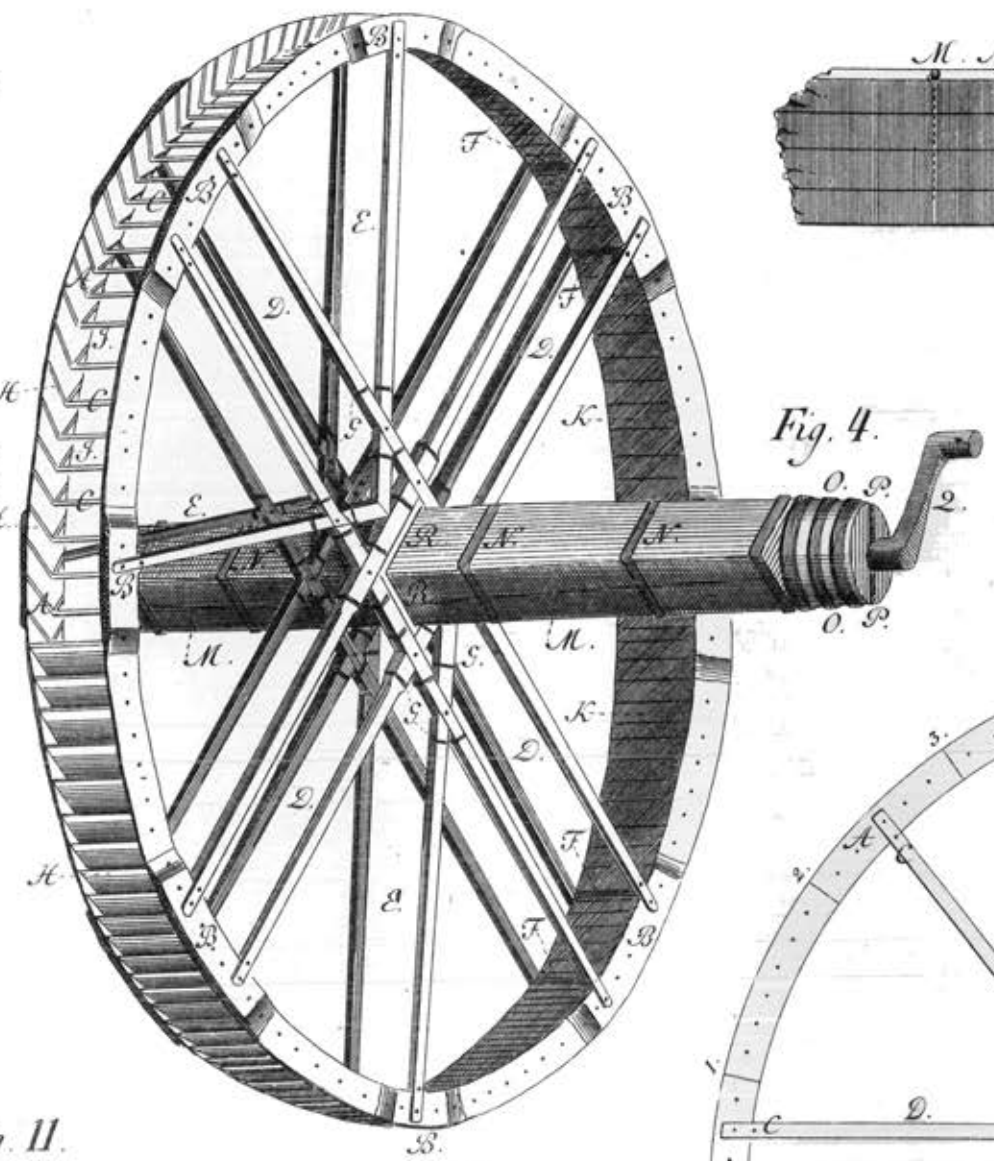
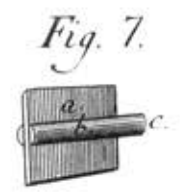
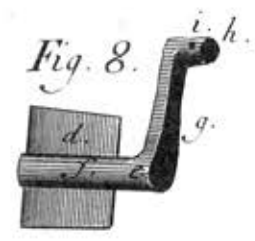
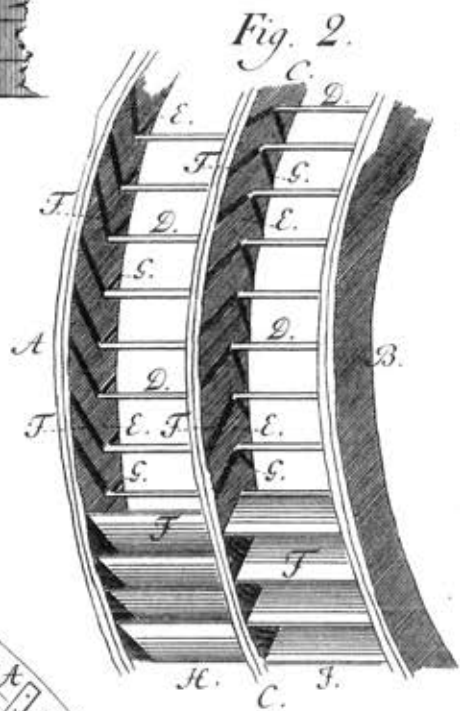
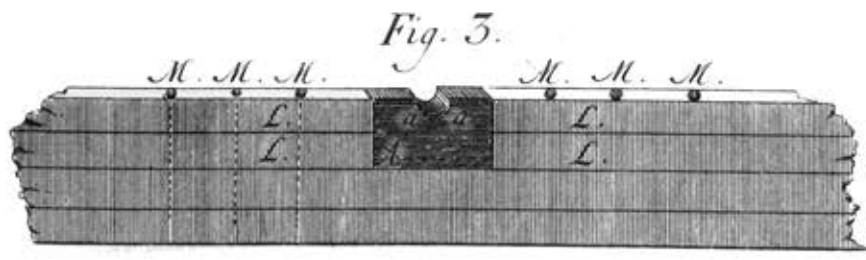
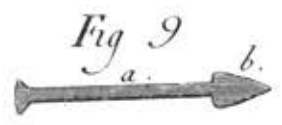

Fig. 1.

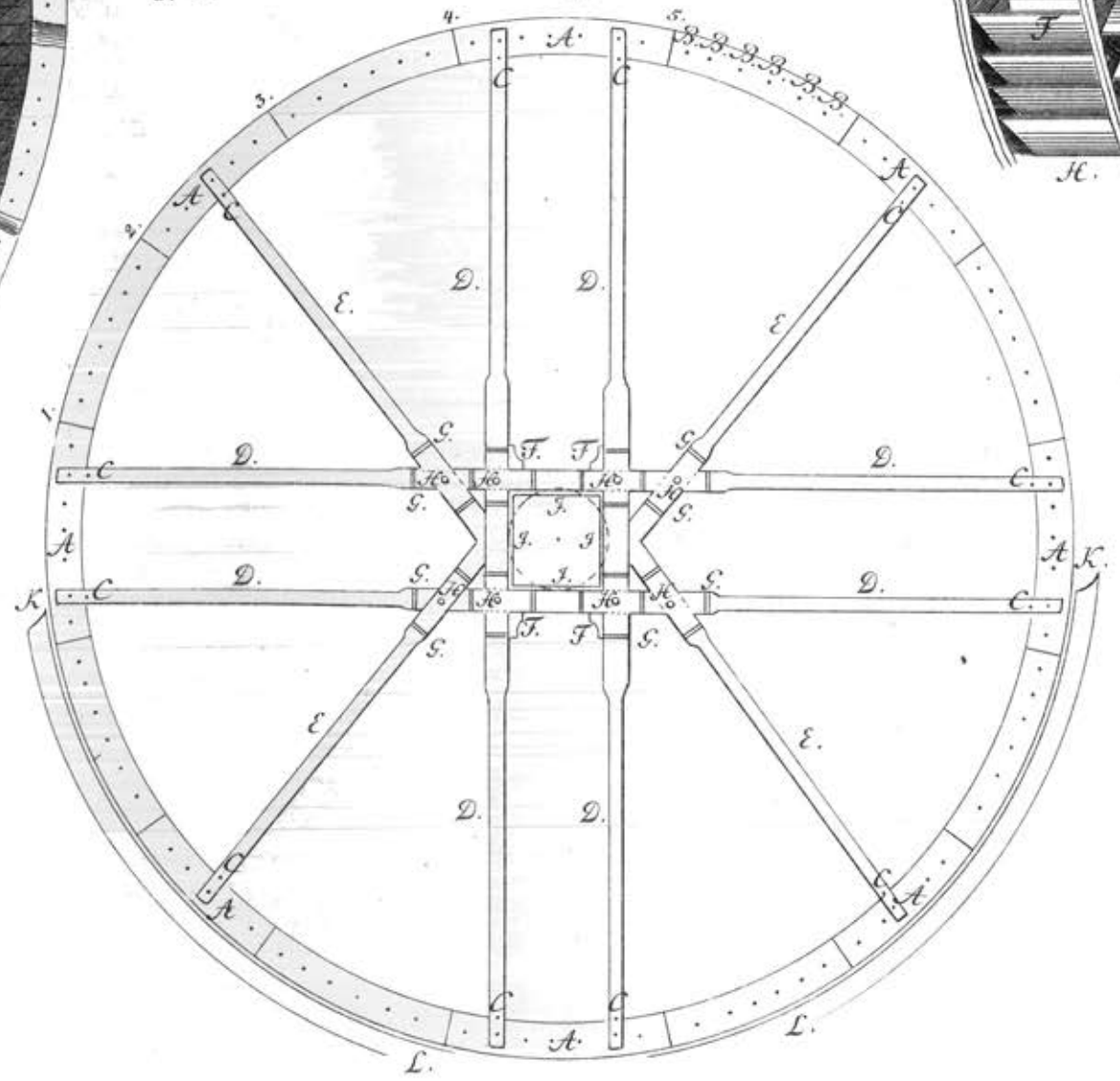

Fig. 11.

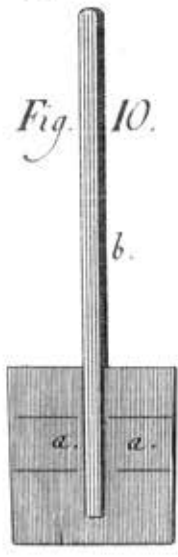
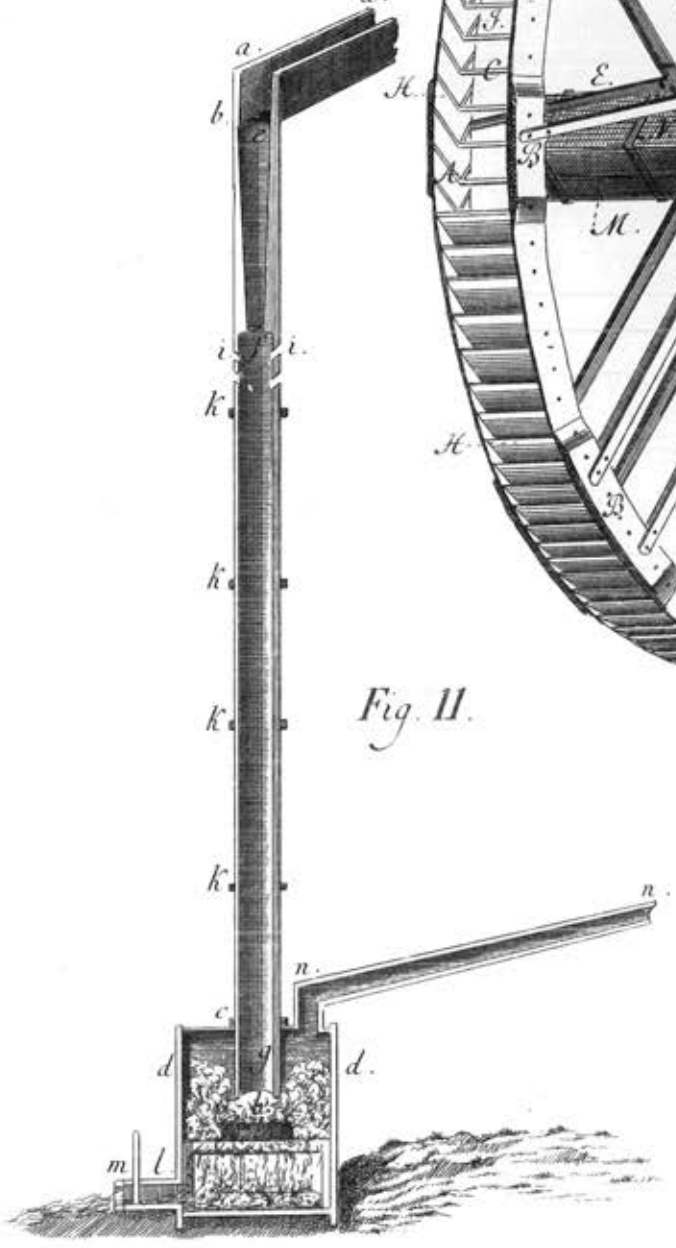

Fig. 10.

H. 44

Fig. 1.

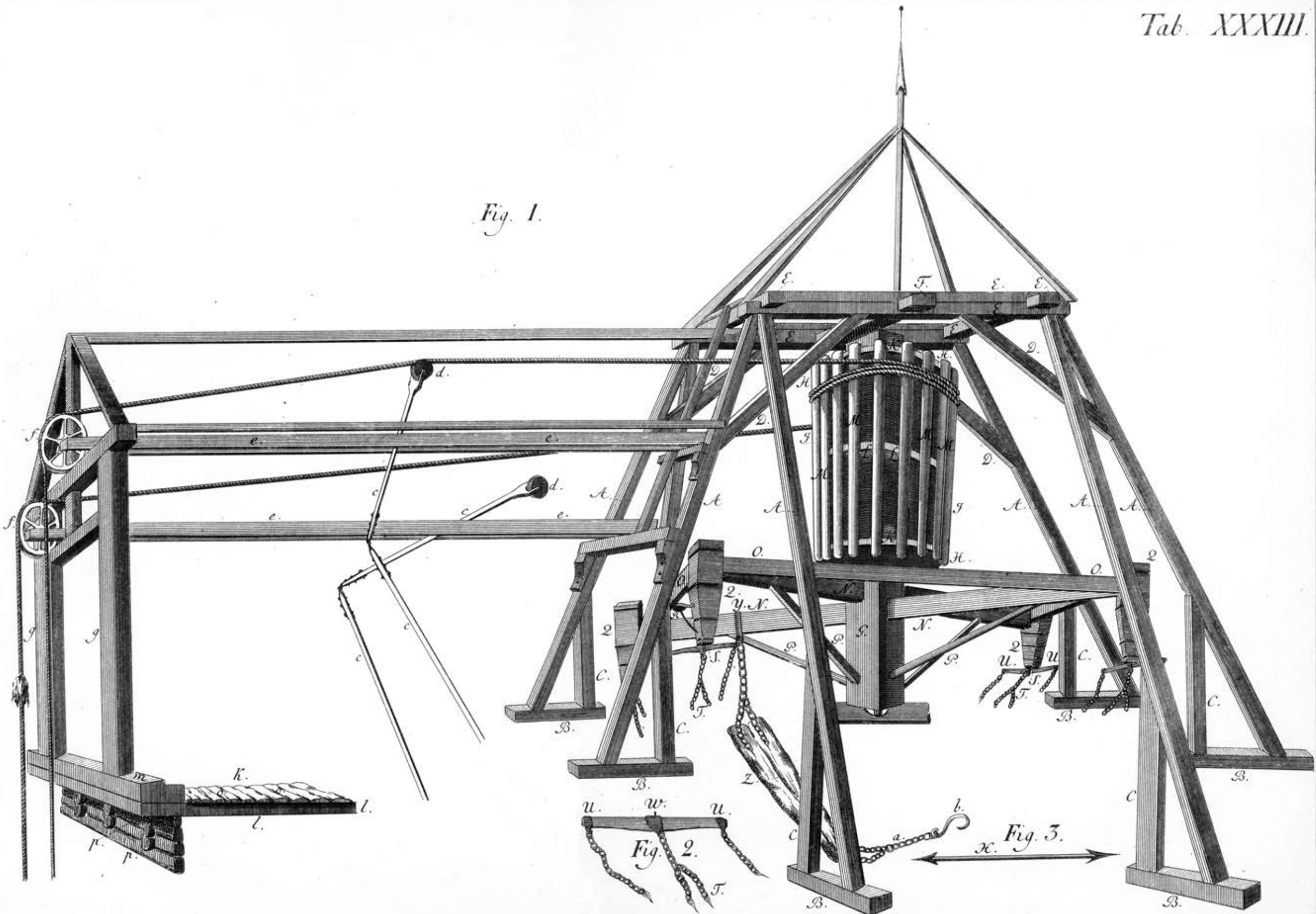

Fig. 1.

